

RONDO  
**DUPLEX**  
Stud System®

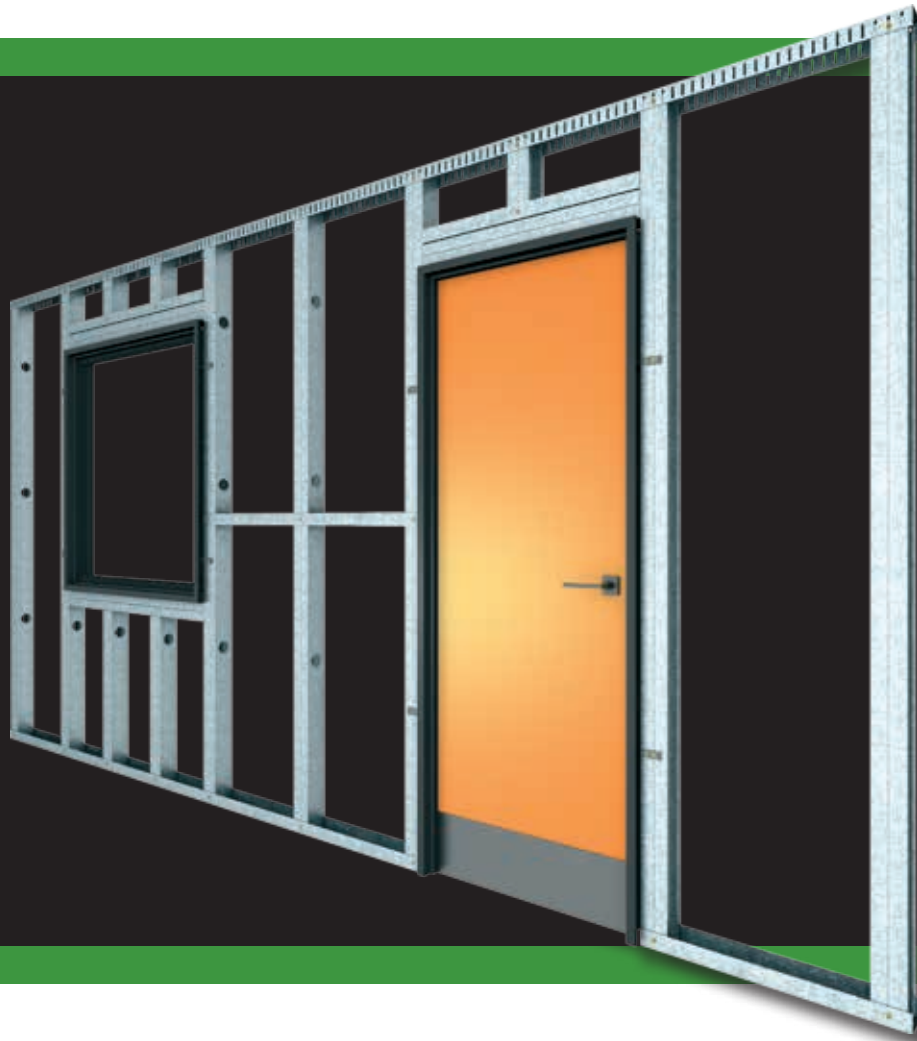

INTERNAL  
DOOR, WALL & GLAZING  
STUD FRAMING

JULY 2017

**RONDO®**



# RONDO DUPLEX STUD® INTERNAL FRAMING SYSTEM

Rondo DUPLEX is one Stud that does the job of two.

It's perfect for door openings and glazing in internal wall framing applications where you typically need to install a boxed stud configuration. Less products to install means much quicker installations, delivering you with the all-important labour cost savings.

It can also be used as a Wall Stud where the use of standard Steel Studs would require installation at closer centres. In this application, our DUPLEX Stud® provides additional load capacity and reduces not only the material cost but labour cost as well.

Partnered with new Fixing Brackets and existing medium gauge Slotted Deflection Head Track, the Rondo DUPLEX Stud System® is the perfect addition to the Rondo family of Wall Framing Systems.

## SUITABLE FOR

- Replacing single boxed studs to support door frames
- Internal glazing and door jambs
- Access openings for services within the wall framing
- Internal Load Bearing Walls by Rondo Engineered Design
- Incorporation into standard Rondo narrow flange steel internal wall framing

## SPECIAL FEATURES

- Greater load capacity than standard narrow flange wall systems negating the necessity for boxed or back to back configurations or the reducing of Stud centres.
- Integrated with the Rondo medium gauge Slotted Deflection Head Track providing better, positive connections
- Like all Rondo Steel Studs, DUPLEX can be manufactured in custom lengths to suit your project
- DUPLEX Studs are made from G2 grade steel for optimum cost efficiency
- DUPLEX Studs are made from steel with a minimum gal coating of Z275
- Higher walls can be achieved before noggings are required
- Central rib on fixing flange allows for vertical alignment of wall linings

## IMPORTANT NOTE:

***Rondo recommends its products and systems are installed by a qualified tradesperson and according to the relevant codes and standards.***

***Rondo recommends that before acting on any advice or opinion in this manual, you should seek professional advice in light of your own architectural and building requirements.***

## CONTENTS:

**RONDO DUPLEX STUD® FRAMING SYSTEM COMPONENTS** 2

**SECTION PROPERTIES** 3

### TYPICAL APPLICATION DETAILS

DUPLEX STUD® 4

STANDARD DOOR OPENING 5

WIDE DOOR OPENING 6

### INSTALLATION DETAILS

TYPICAL DUPLEX STUD SYSTEM® 7

BASE WALL TRACK 8

SLOTTED DEFLECTION HEAD TRACK 9

NOGGINGS 10

DOOR FRAMING 12

DOOR FRAME & GLAZING HEADER DETAILS 14

FIXING BRACKETS 15

### DESIGN TABLES

WALL HEIGHTS 16

### DESIGN CHARTS

DOOR OPENING 17

GLAZING OPENING 18

GLAZING OPENING: SILL & HEADERS 19

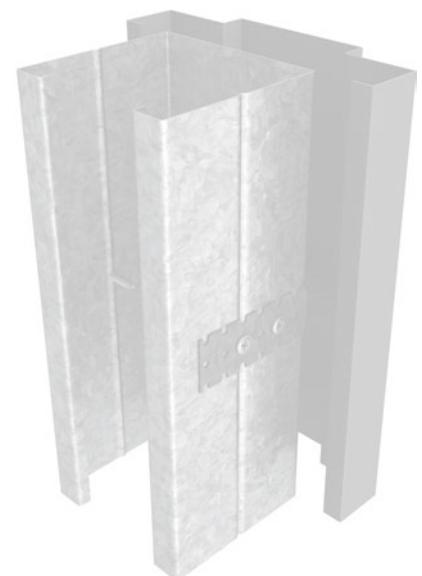

# RONDO DUPLEX COMPONENTS

## DUPLEX STUD®

DU64	64mm (w) x 60mm (h) Rondo DUPLEX Stud® x 0.70bmt
DU76	76mm (w) x 60mm (h) Rondo DUPLEX Stud® x 0.70bmt
DU92	92mm (w) x 60mm (h) Rondo DUPLEX Stud® x 0.70bmt

## DUPLEX STUD®



DU64/DU76/DU92

## WALL TRACK

492	64mm (w) x 28mm (h) x 0.70bmt Wall Track (hemmed)
494	76mm (w) x 28mm (h) x 0.70bmt Wall Track (hemmed)
496	92mm (w) x 28mm (h) x 0.70bmt Wall Track (hemmed)

## WALL TRACK

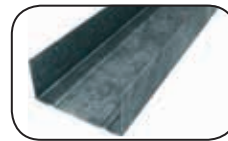

492/494/496

## SLOTTED DEFLECTION HEAD TRACK

S497	64mm (w) x 0.70bmt Slotted Deflection Head Track
S498	76mm (w) x 0.70bmt Slotted Deflection Head Track
S499	92mm (w) x 0.70bmt Slotted Deflection Head Track

## SLOTTED DEFLECTION HEAD TRACK



S497/S498/S499

## DEFLECTION HEAD TRACK

497	64mm (w) x 50mm (h) Deflection Head Track with Hem
498	76mm (w) x 50mm (h) Deflection Head Track with Hem
499	92mm (w) x 50mm (h) Deflection Head Track with Hem

## DEFLECTION HEAD TRACK



497/498/499

## NOGGINGS

214	64mm (w) x 0.70bmt Double Punched Nogging Track
215	76mm (w) x 0.70bmt Double Punched Nogging Track
216	92mm (w) x 0.70bmt Double Punched Nogging Track
222	FAST-FIX® Nogging to suit Standard Stud Centres

## NOGGINGS



214/215/216

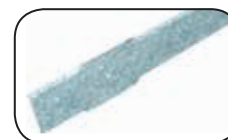

222

## FIXING BRACKETS

562	Universal DUPLEX Stud® Bracket
564	Header Bracket to suit 64mm DUPLEX Stud®
567	Header Bracket to suit 76mm DUPLEX Stud®
569	Header Bracket to suit 92mm DUPLEX Stud®



562



564/567/569

# SECTION PROPERTIES

DUPLEX Stud®

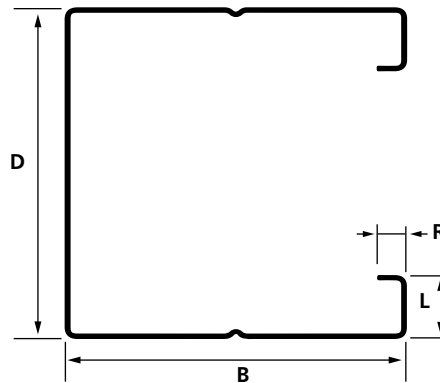

## MATERIAL SPECIFICATIONS

**Steel Grade:** G2 Z275 to AS1397

**Yield Strength:**  $F_y = 270$  MPa

**Ultimate:**  $F_u = 330$  MPa

**Coating Grade:** Z275 – 275g/m<sup>2</sup> zinc

TABLE 1: SECTION PROPERTIES

BMT	PART NO	DIMENSIONS						GROSS AREA mm <sup>2</sup>	MOMENT OF AREA		SECTION MODULUS		TORSION Constant J mm <sup>4</sup>	WARPING Constant I <sub>w</sub> 10 <sup>6</sup> mm <sup>6</sup>
		D mm	B mm	L mm	R mm	X <sub>c</sub> mm	Y <sub>c</sub> mm		I <sub>xx</sub> mm <sup>4</sup>	I <sub>yy</sub> mm <sup>4</sup>	Z <sub>xx</sub> mm <sup>3</sup>	Z <sub>yy</sub> mm <sup>3</sup>		
0.70	DU64	63.5	60	12	5.0	24.9	31.8	145.1	107	74.1	3408	2109	23.7	79.91
	DU76	76.2	60	12	5.0	23.5	38.1	153.9	160	79.0	4248	2163	25.1	110.7
	DU92	92.1	60	12	5.0	21.9	46.1	164.9	244	84.4	5353	2214	26.9	158.5

NOTE: Section properties are gross and should be appropriately factored in accordance with AS/NZS4600 for design purposes, as applicable.

# TYPICAL APPLICATION DETAILS

## DUPLEX Stud®

Rondo DUPLEX is one Stud that does the job of two.

The DUPLEX Stud® is located at glazing and door openings in internal wall framing applications. The load carried by the DUPLEX Stud® is greater than that carried by standard Wall Studs, which are typically boxed together for strengthening of the jamb.

With less products to install, the Rondo DUPLEX Stud System® provides a faster and more cost-effective construction solution.



■ DUPLEX STUD®



■ BOXED STUDS

**Note:** The Rondo DUPLEX Stud System® is for **internal** use only and has been designed as a conventional drywall framing system. The information contained in this manual is of a general nature and is therefore based upon typical internal requirements.

In addition to the details herein, Rondo can prepare an Engineered Solution, utilising the Rondo DUPLEX Stud System® for a specific project or application, such as inter-tenancy walls in high rise apartment buildings which are required to accommodate higher internal design pressures. In this instance, the specification provided by our engineers is tailored to the specific project and considers all facets of the framing requirements, and supersedes the general details within this manual.

## Standard Door Opening

Framing around glazing and doors require additional fixings and framing members to carry the extra loadings in these areas and prevent long term serviceability problems.

The Rondo DUPLEX Stud® is a newly designed lightweight steel Wall Stud which can be used to frame door openings and glazing, without the need for boxing of the wall studs. The DUPLEX Stud® has been designed to carry the concentrated loads at these locations.

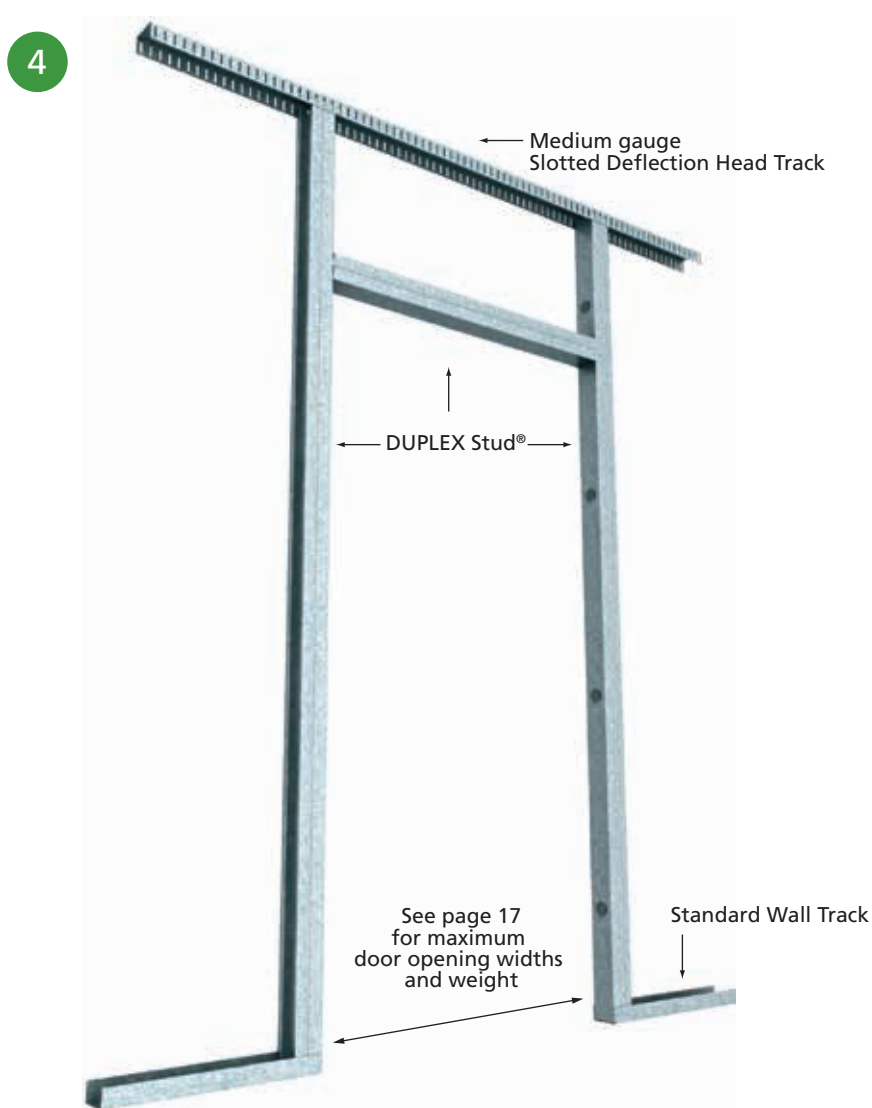

INTERNAL DOOR FRAMING: STANDARD OPENING

# TYPICAL APPLICATION DETAILS (continued)

## Wide Door Opening

Where the head height over the door is less than 600mm, the standard door frame fixing requirements shown on page 5 will suffice, thereafter the installation details provided below should be followed.

5

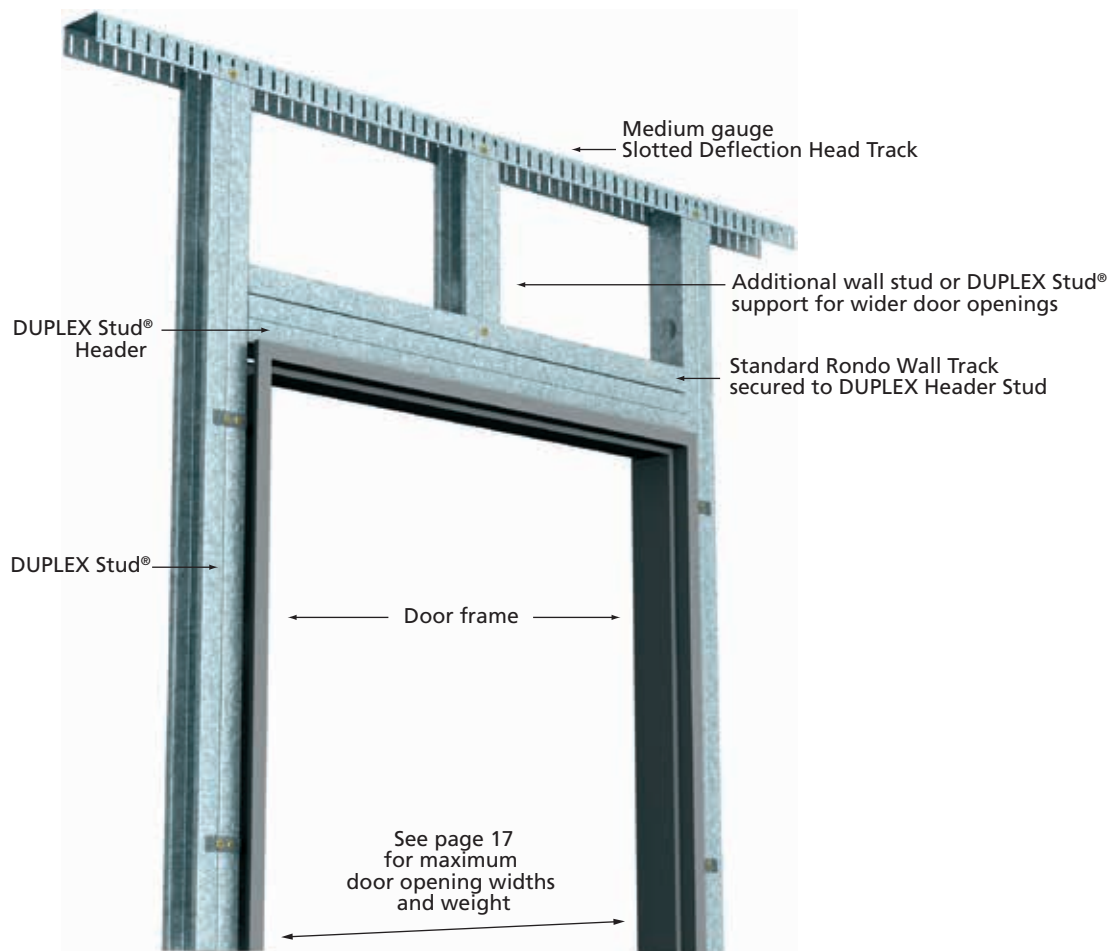

■ INTERNAL DOOR FRAMING: WIDE OPENING



# INSTALLATION DETAILS

Typical DUPLEX Stud System®

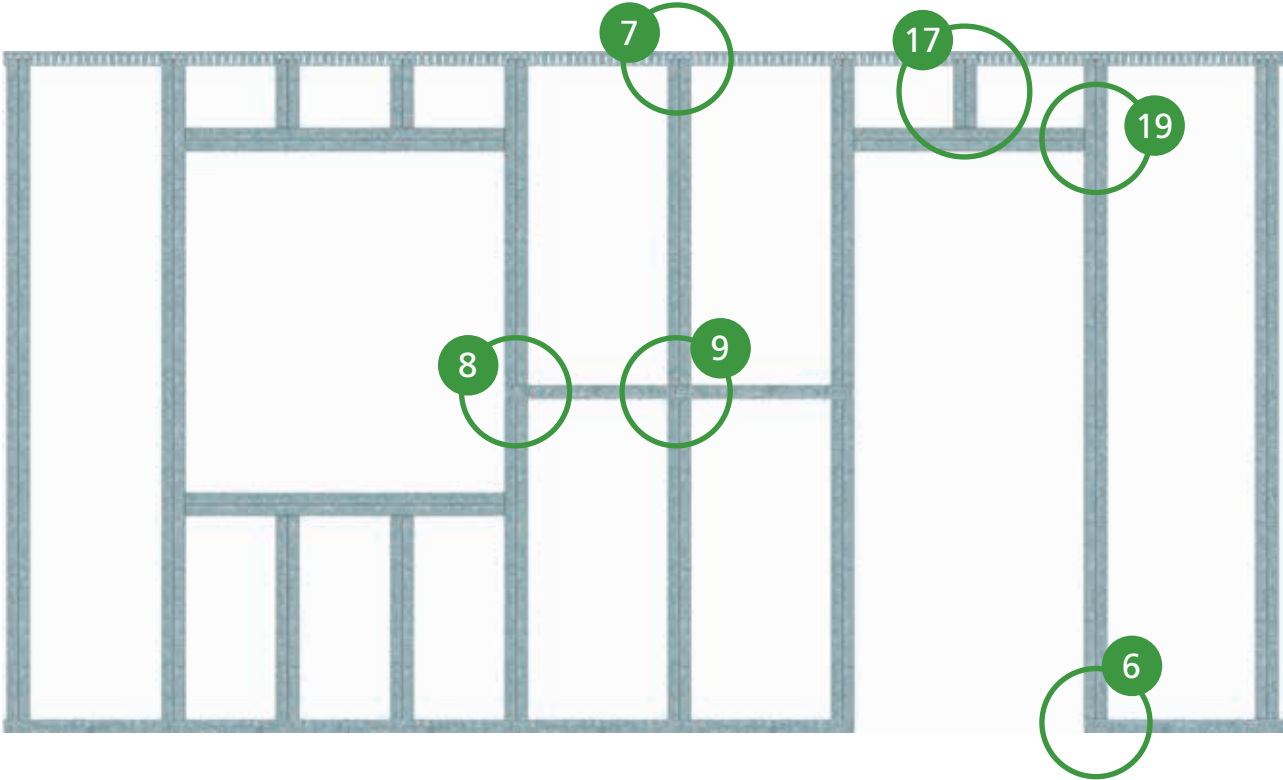

Circled areas on the drawing refer to figures shown in more detail on the following pages.

## INSTALLATION DETAILS (continued)

### Base Wall Track

The floor track is the standard 0.70bmt Rondo Wall Track with the width to match the DUPLEX Stud® being used.

Fixings should be no more than 100mm from the end of the Wall Track and spaced thereafter at no more than 600mm centres.

The DUPLEX Stud® can be installed into the Wall Track in the conventional manner unless specified otherwise by a Rondo Engineer.

When the DUPLEX Stud® is installed to support a simple door frame, the Stud should be screwed to the Wall Track both sides with #8 wafer head screws.

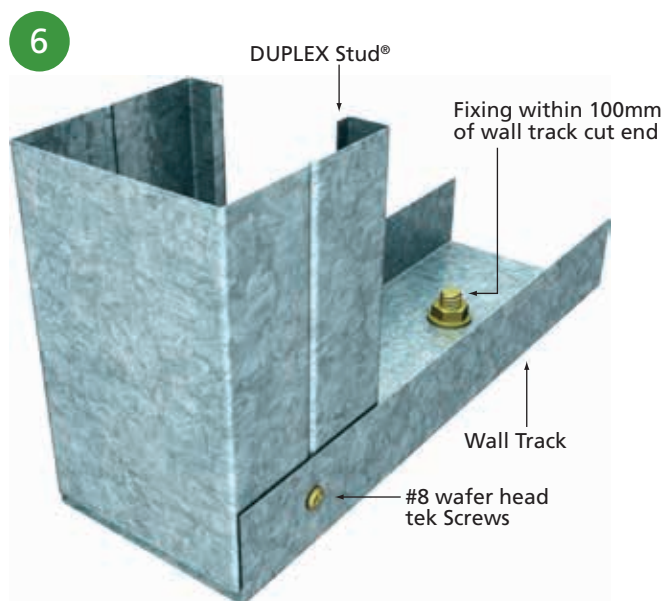

■ BASE WALL TRACK

## Medium Gauge Slotted Deflection Head Track

Rondo medium gauge Slotted Deflection Head Track is the preferred top Track option providing a more secure top fixing to the DUPLEX Stud®. This is particularly relevant in DUPLEX Stud® Walls where the DUPLEX Stud® is used as a wall member. However, in standard Stud Wall Framing where DUPLEX is just being installed around door and glazing openings, standard Rondo Deflection Head Tracks can still be used.

Both the medium gauge Slotted Deflection Head Track and standard Deflection Head Track fixings to the structure should be spaced at no more than 600mm centres with the end fixings at no more than 100mm from the cut end.

The DUPLEX Stud® is secured to the medium gauge Slotted Deflection Head Track as detailed in Figure 7b.

**NOTE:** For seismic applications, Rondo does not recommend the use of Slotted Deflection Head Track for wall framing applications. In this instance, check with the Rondo Design Team before commencing works.

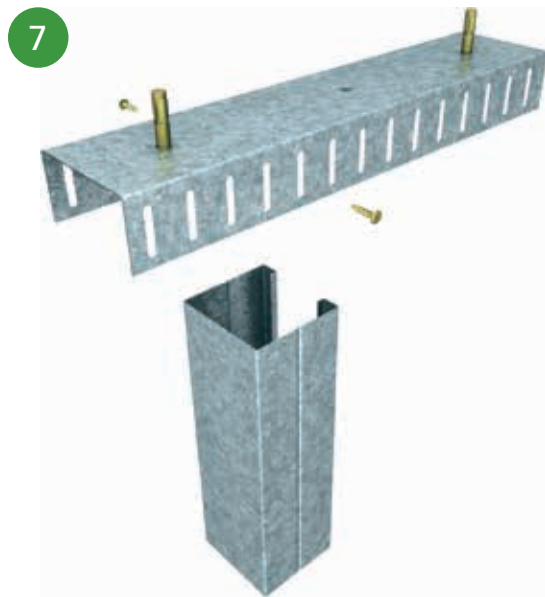

# INSTALLATION DETAILS (continued)

## Noggings

Noggings play an important part of the DUPLEX Stud® Internal Wall Framing System as they provide lateral and torsional restraint to the DUPLEX Stud®, thereby increasing the load that can be carried by the DUPLEX Stud®.

Rondo produces a couple of nogging alternatives that can be used with the DUPLEX Stud® including a Double-Punched Nogging Track and a newly released FAST-FIX Nogging®.

### DOUBLE-PUNCHED NOGGING TRACK

The opening of the Double-Punched Nogging Track is approximately 15mm wider than the DUPLEX Stud®, and therefore, the installer should ensure the DUPLEX Stud® is centred in the opening and screwed off both sides accordingly. This will not compromise the benefits of using the Double Punched Nogging Track.

Refer to Figures 8 & 9 for installation details.

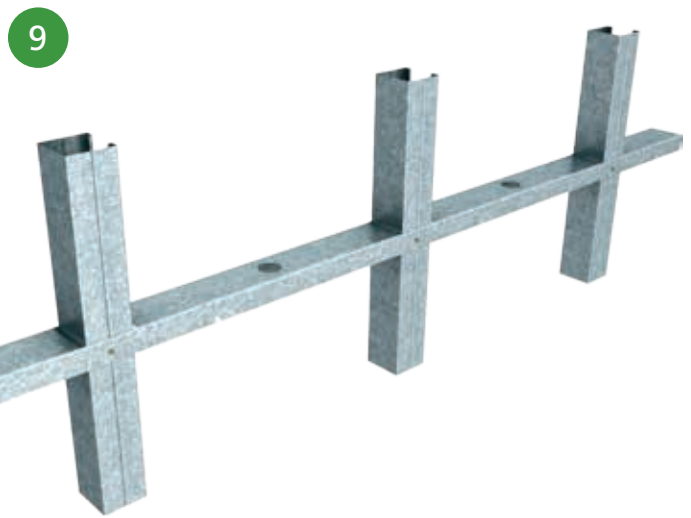
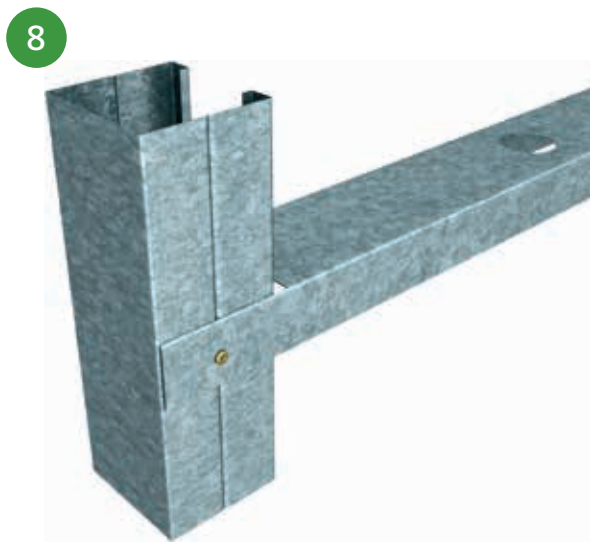

■ DOUBLE-PUNCHED NOGGING TRACK INSTALLATION

### DUPLEX STUD® NOGGING REQUIREMENTS

The Nogging requirements shown below are applicable for both the Rondo Double-Punched Nogging Track and the FAST-FIX Nogging® Track only.

TABLE 2: DUPLEX STUD® NOGGING REQUIREMENTS

WALL HEIGHT (m)	LINING CONDITION	NUMBER OF NOGGINGS
0 – 6.0	Both sides	0
6.0 – 8.8		1
0 – 4.0	Lined one side	1
4.0 – 8.0		2
8.0+		3

**NOTES:**

1. Walls connected to the underside of a concrete slab must be installed with deflection head track and an additional row of noggings 100mm below the head track if standard Deflection Head Track is used, and, the wall is unlined or only lined one side.
2. The above nogging table is not to be used in conjunction with conventional Rondo Stud framing.

**NEW  
PRODUCT.  
WATCH THIS  
SPACE.**

### FAST-FIX NOGGING® ALTERNATIVE

Our new Rondo FAST-FIX Nogging® is an alternative to Rondo Nogging Track.

The Rondo FAST-FIX Nogging® can be installed after the framing is complete, providing faster overall installation time for wall framing.

Refer to Figure 10 for installation details of the Rondo FAST-FIX Nogging®. For DUPLEX Stud® Nogging requirements, see Table 2 on page 10.

10

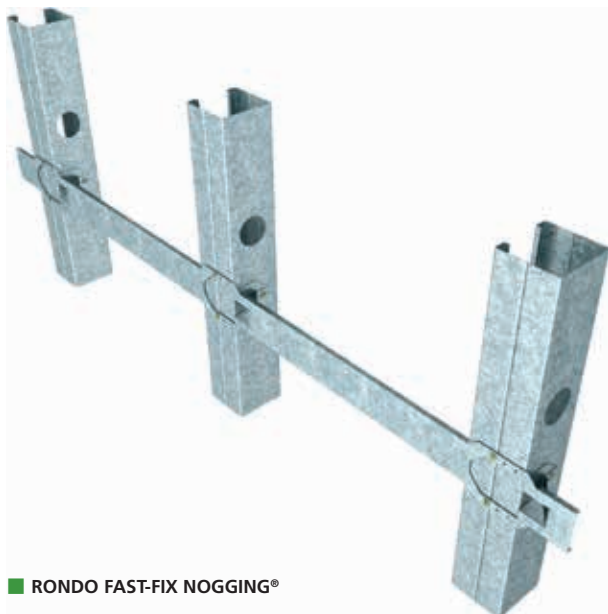

■ RONDO FAST-FIX NOGGING®

10a



■ FRONT VIEW OF FAST-FIX NOGGING®

10b

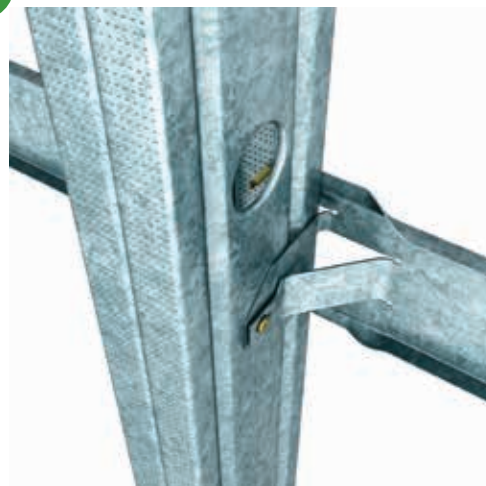

■ BACK VIEW OF FAST-FIX NOGGING®

# INSTALLATION DETAILS (continued)

## Door Framing

Rondo DUPLEX Stud® was initially designed to support door frames in internal partition drywalls by replacing the standard boxed stud supports with a single stud to offer cost savings during construction.

Simply placing the DUPLEX Stud® into standard 64, 76 or 92mm Stud Wall Framing at every door opening without the necessity to box two single studs together will offer significant savings – and of course, the larger the job the greater the savings.

The same applies to the framing of glazing within internal stud walls with the DUPLEX Stud® providing a robust support for glazing systems, with increased capacity to support large window openings both vertically and horizontally.

11

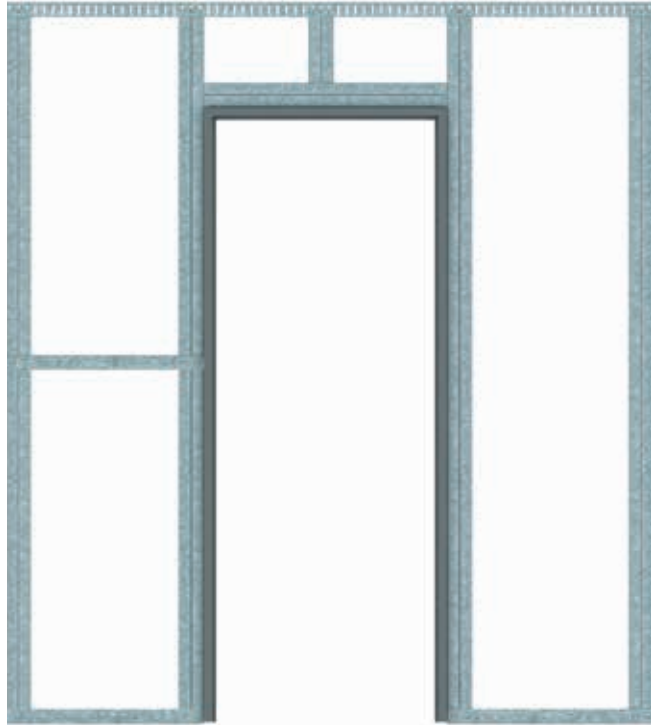

12

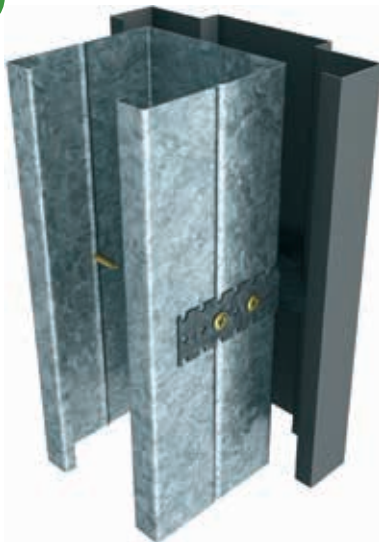

■ DUPLEX STUD® DOOR FRAMING

13



■ BOXED SINGLE STUDS DOOR FRAMING

14

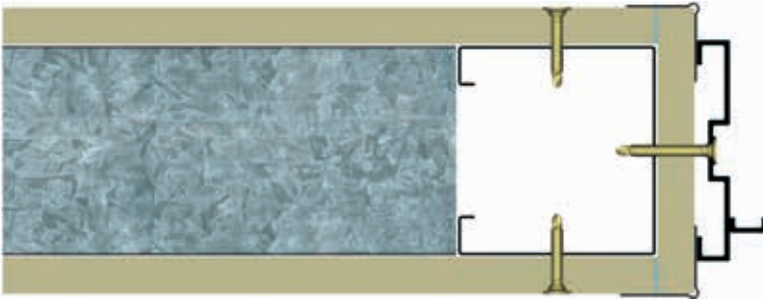

■ TYPICAL DETAIL FOR ALUMINIUM DOOR FRAME SECURED TO DUPLEX STUD®. DETAIL IS SIMILAR FOR ALUMINIUM GLAZING

15

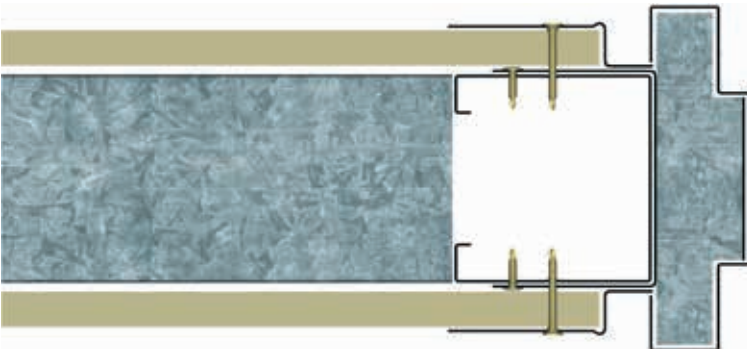

■ TYPICAL DETAIL FOR STEEL DOOR FRAME SECURED TO DUPLEX STUD®

16

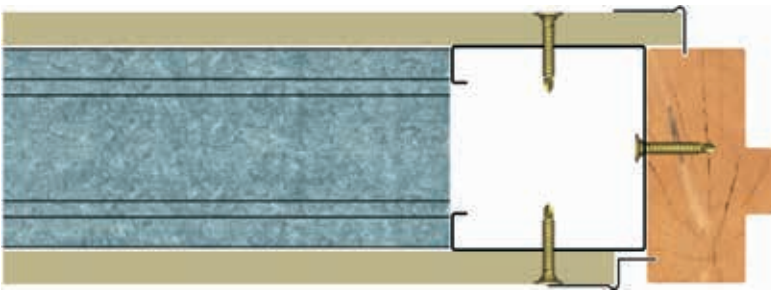

■ TYPICAL DETAIL FOR TIMBER DOOR FRAME SECURED TO DUPLEX STUD® WITH OPTIONAL SHADOWLINE DETAIL SHOWN

# INSTALLATION DETAILS (continued)

## Door Frame & Glazing Header Details

When installing 'jack' studs as shown in Figure 17, they should be screwed off top and bottom using #10 wafer head screws on each side of the stud.

Figure 18 shows fixing of Header Bracket to the DUPLEX Stud® and the correct positioning of the Header Bracket to Header DUPLEX Stud®. When it is used as a sill member, invert the Bracket.

Figure 19 shows the completed installation with track installed over the Header DUPLEX Stud® to accept Jack Studs as Figure 17.

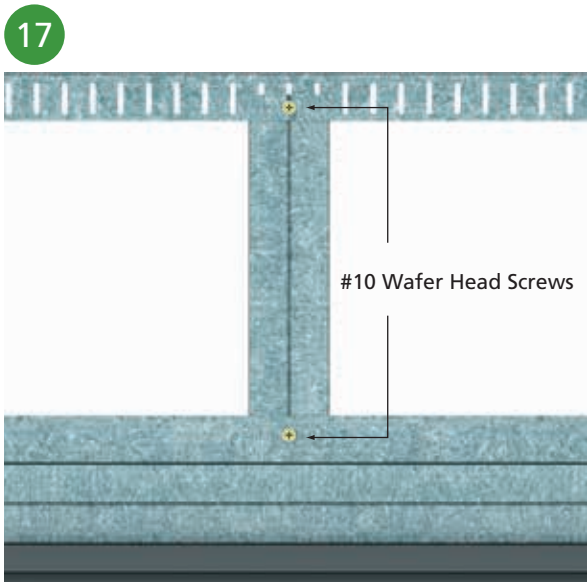

■ INSTALLING 'JACK' STUDS USING DUPLEX STUD®

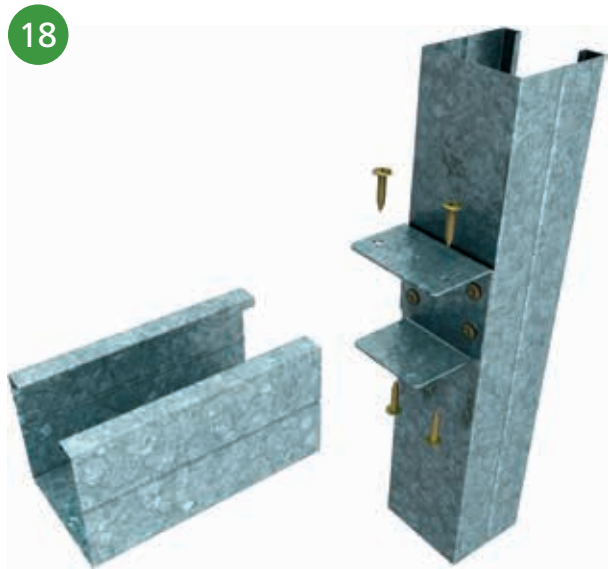

■ INSTALLATION OF DUPLEX HEADER STUD

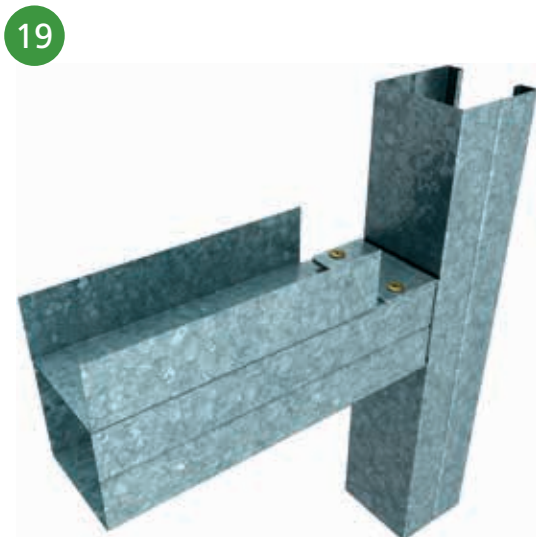

■ INSTALLATION OF DUPLEX HEADER STUD WITH TRACK FOR 'JACK' STUDS



■ HEADER BRACKET



## Fixing Brackets

The Rondo DUPLEX Stud System® incorporates a new universal fixing bracket which can be used for both the top and bottom fixing where structurally necessary.

New Brackets have also been developed to secure the DUPLEX Header Stud to the Jamb Studs in door and glazing openings.

21

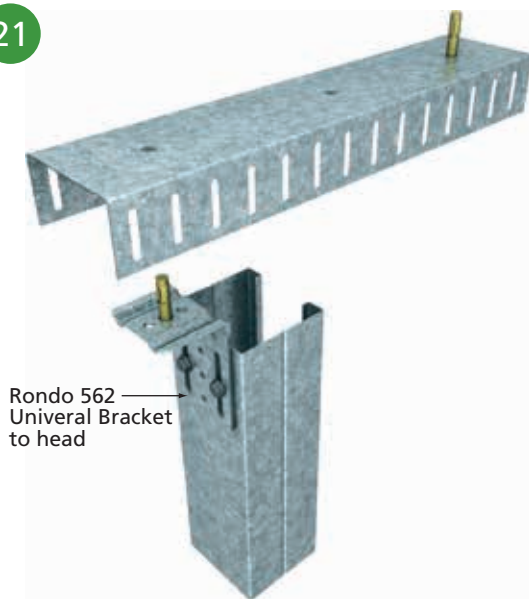

■ RONDO 562 UNIVERSAL BRACKET FIXING DUPLEX STUD® TO MAXITRACK® DEFLECTION HEAD TRACK

22

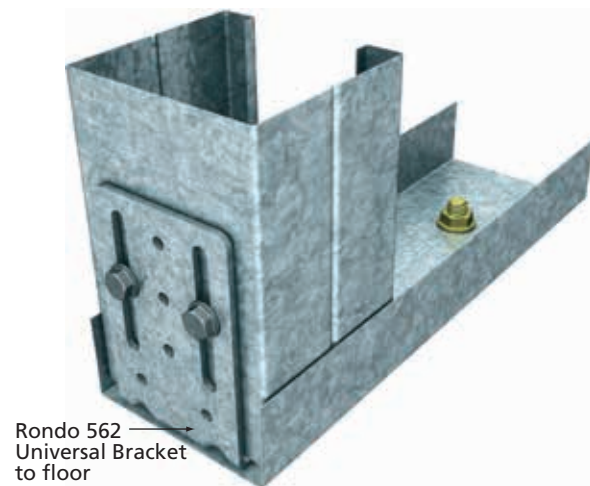

■ RONDO 562 UNIVERSAL BRACKET FIXING DUPLEX STUD® TO WALL TRACK

23

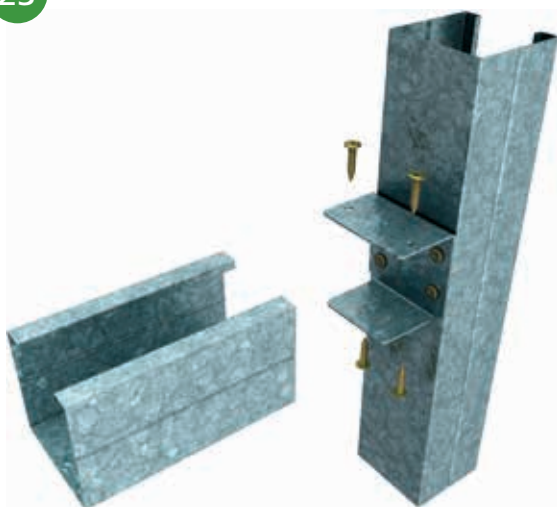

■ NEW HEADER BRACKET FIXING DUPLEX STUD® TO DUPLEX STUD®

# DESIGN TABLES

## DUPLEX Wall Heights

TABLE 3: MAXIMUM WALL HEIGHT TABLES

STUD WIDTH		64mm			76mm			92mm		
STUD CENTRES (mm)		300	450	600	300	450	600	300	450	600
<b>PLASTERBOARD LININGS (mm)</b>		<b>H/240</b>								
LINED BOTH SIDES	1x10mm	4970	4490	4190	5710	5080	4670	6390	5620	5110
	1x13mm	5150	4710	4440	6120	5580	5070	6860	6190	5660
	1x16mm	5300	4830	4530	6340	5800	5070	7060	6380	5660
LINED ONE SIDE	1x10mm	4500	3930	3570	5150	4500	4080	5930	5180	4700
	1x13mm	4560	3980	3610	5290	4630	4200	5950	5180	4700
	1x16mm	4580	4000	3630	5330	4660	4220	5960	5180	4700
<b>PLASTERBOARD LININGS (mm)</b>		<b>H/360</b>								
LINED BOTH SIDES	1x10mm	4360	3950	3700	5070	4560	4220	5700	5070	4650
	1x13mm	4520	4140	3920	5420	4970	4690	6090	5540	5180
	1x16mm	4680	4290	4050	5630	5190	4890	6290	5740	5370
LINED ONE SIDE	1x10mm	3930	3430	3120	4500	3930	3570	5180	4520	4110
	1x13mm	4010	3510	3200	4670	4110	3750	5250	4590	4150
	1x16mm	4030	3540	3220	4720	4160	3790	5270	4600	4160

**NOTES:**

1. Deflection Limit is span/240 (or span/360 as applicable) to a maximum of 30mm at 0.25 kPa, in accordance with the BCA Specification C1.8 – 2005.
2. Maximum wall heights refer to the structural wall heights only. Maximum wall heights may be reduced from those in the table for fire rated walls, refer to your plasterboard manufacturer for this information.
3. The tabulated heights are not for axial loads but do include self weight and lateral pressures.
4. Shelf loading is not permitted on the tabulated wall heights.
5. Loadings: a. Pultimate = 0.375 kPa  
b. Pservice = 0.25 kPa
6. These walls are not for external applications.
7. All loading in accordance with AS1170:2002.
8. Walls analysed in accordance with AS4600:2005.
9. Noggings in accordance with table shown on page 10.
10. BMT = Base Metal Thickness.
11. The above wall heights are suitable for a single layer of plasterboard only.

# DESIGN CHARTS

## Door Opening

**TABLE 4: DOOR OPENINGS JAMB STUDS**

WALL HEIGHT H (mm)	OPENING WIDTH W (mm)		
	64 x 0.70bmt DUPLEX Stud®	76 x 0.70bmt DUPLEX Stud®	92 x 0.70bmt DUPLEX Stud®
2400	2380	2760	3080
2500	2160	2520	2800
2600	1960	2300	2580
2700	1780	2120	2380
2800	1640	1960	2200
2900	1500	1800	2040
3000	1340	1680	1900
3100	1160	1560	1780
3200	1020	1440	1680
3300	880	1340	1560
3400	760	1240	1480
3500	660	1160	1380
3600	560	1060	1320
3700	–	940	1240
3800	–	840	1160
3900	–	740	1080
4000	–	660	1010

**NOTES:**

1. Deflection Limit is span/240 to a maximum of 30mm at 0.25 kPa, in accordance with the BCA Specification C1.8 – 2005.
2. Maximum wall heights refer to the structural wall heights only. Maximum wall heights may be reduced from those in the table for fire rated walls, refer to your plasterboard manufacturer for this information.
3. The tabulated heights include self weight and lateral pressures, combined with a door height up to 2100mm and weight up to 50kg/m<sup>2</sup>.
4. Shelf loading is not permitted on the tabulated wall heights.
5. Loadings: a. Pultimate = 0.375 kPa  
b. Pservice = 0.25 kPa
6. These walls are not for external applications.
7. All loading in accordance with AS1170:2002.
8. Walls analysed in accordance with AS4600:2005.
9. Noggings in accordance with table shown on previous page.
10. BMT = Base Metal Thickness.
11. The above wall heights are suitable for a single layer of plasterboard only.
12. Jamb studs to be installed using the Universal Bracket Rondo Part No 562, per details 21 & 22 on page 15.

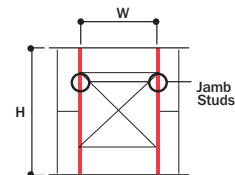
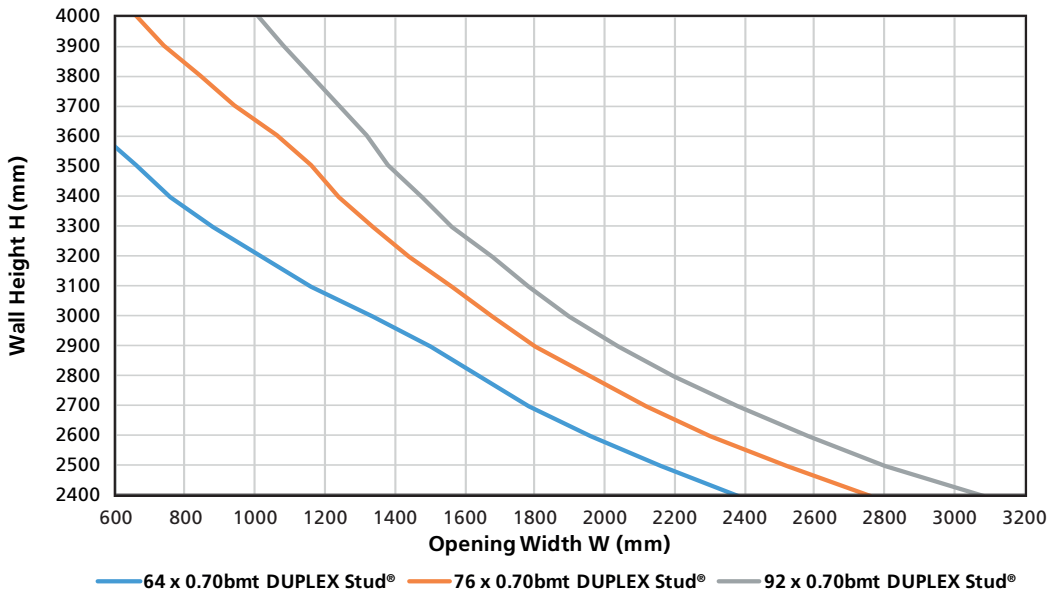

# DESIGN CHARTS (continued)

## Glazing Opening

**TABLE 5: GLAZING OPENINGS JAMB STUDS**

WALL HEIGHT H (mm)	OPENING WIDTH W (mm)		
	64 x 0.70bmt DUPLEX Stud®	76 x 0.70bmt DUPLEX Stud®	92 x 0.70bmt DUPLEX Stud®
2400	3360	4740	6080
2500	2900	4320	5560
2600	2500	3960	5080
2700	2180	3560	4680
2800	1880	3120	4300
2900	1640	2760	3980
3000	1420	2420	3680
3100	1220	2140	3400
3200	1060	1900	3160
3300	920	1680	2880
3400	780	1480	2580
3500	660	1300	2300
3600	560	1140	2080
3700	–	1000	1860
3800	–	880	1680
3900	–	780	1500
4000	–	680	1340

**NOTES:**

1. Deflection Limit is span/240 to a maximum of 30mm at 0.25 kPa, in accordance with the BCA Specification C1.8 – 2005.
2. Maximum wall heights refer to the structural wall heights only. Maximum wall heights may be reduced from those in the table for fire rated walls, refer to your plasterboard manufacturer for this information.
3. The tabulated heights include self weight and lateral pressures, assuming window is adequately fixed to all four sides of the opening.
4. Shelf loading is not permitted on the tabulated wall heights.
5. Loadings: a. Pultimate = 0.375 kPa  
b. Pservice = 0.25 kPa
6. These walls are not for external applications.
7. All loading in accordance with AS1170:2002.
8. Walls analysed in accordance with AS4600:2005.
9. Noggings in accordance with table shown on previous page.
10. BMT = Base Metal Thickness.
11. The above wall heights are suitable for a single layer of plasterboard only.
12. Jamb studs to be installed using the Universal Bracket Rondo Part No 562, per details 21 & 22 on page 15.

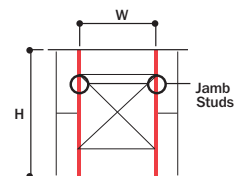
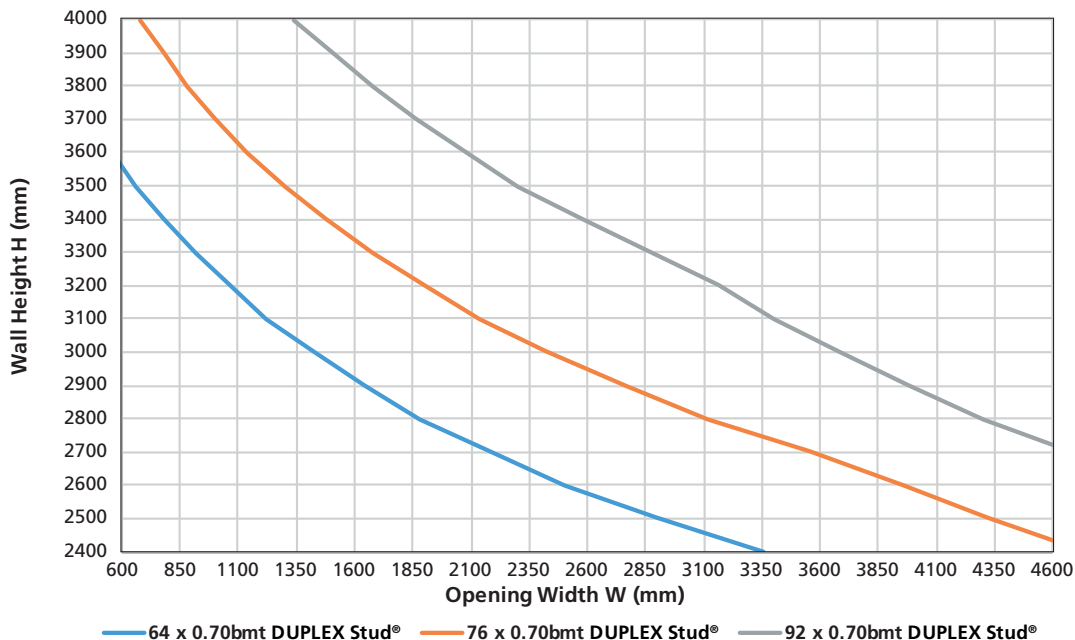

## Glazing Opening: Sill & Headers

**TABLE 6: GLAZING OPENINGS SILLS & HEADERS**

WALL HEIGHT H (mm)	OPENING WIDTH W (mm)					
	64 x 28 x 0.70bmt Wall Track	64 x 0.70bmt DUPLEX Stud®	76 x 28 x 0.70bmt Wall Track	76 x 0.70bmt DUPLEX Stud®	92 x 28 x 0.70bmt Wall Track	92 x 0.70bmt DUPLEX Stud®
2400	2150	2830	2340	3240	2550	3730
2500	2110	2790	2300	3200	2510	3680
2600	2070	2760	2270	3160	2480	3630
2700	2040	2720	2230	3120	2440	3590
2800	2010	2690	2200	3080	2410	3540
2900	1980	2660	2170	3040	2370	3500
3000	1950	2630	2140	3010	2340	3460
3100	1920	2600	2110	2970	2310	3430
3200	1900	2570	2080	2940	2280	3390
3300	1870	2550	2050	2910	2250	3350
3400	1850	2520	2020	2880	2230	3320
3500	1820	2500	2000	2860	2200	3290
3600	1800	2470	1980	2830	2170	3260
3700	1780	2450	1950	2800	2150	3220
3800	1760	2430	1930	2780	2120	3180
3900	1740	2410	1910	2760	2100	3140
4000	1720	2390	1890	2730	2080	3100

**NOTES:**

1. Deflection Limit is span/240 to a maximum of 30mm at 0.25 kPa, in accordance with the BCA Specification C1.8 – 2005.
2. Maximum wall heights refer to the structural wall heights only. Maximum wall heights may be reduced from those in the table for fire rated walls, refer to your plasterboard manufacturer for this information.
3. The tabulated heights include self weight and lateral pressures, assuming window is adequately fixed to all four sides of the opening.
4. Shelf loading is not permitted on the tabulated wall heights.
5. Loadings: a. Pultimate = 0.375 kPa  
b. Pservice = 0.25 kPa
6. These walls are not for external applications.
7. All loading in accordance with AS1170:2002, assuming half wall height as load width onto sill.
8. Walls analysed in accordance with AS4600:2005.
9. Noggings in accordance with table shown on previous page.
10. BMT = Base Metal Thickness.
11. The above wall heights are suitable for a single layer of plasterboard only.
12. Sills and Headers to be installed using the Rondo Header Bracket, per detail 23 on page 15.

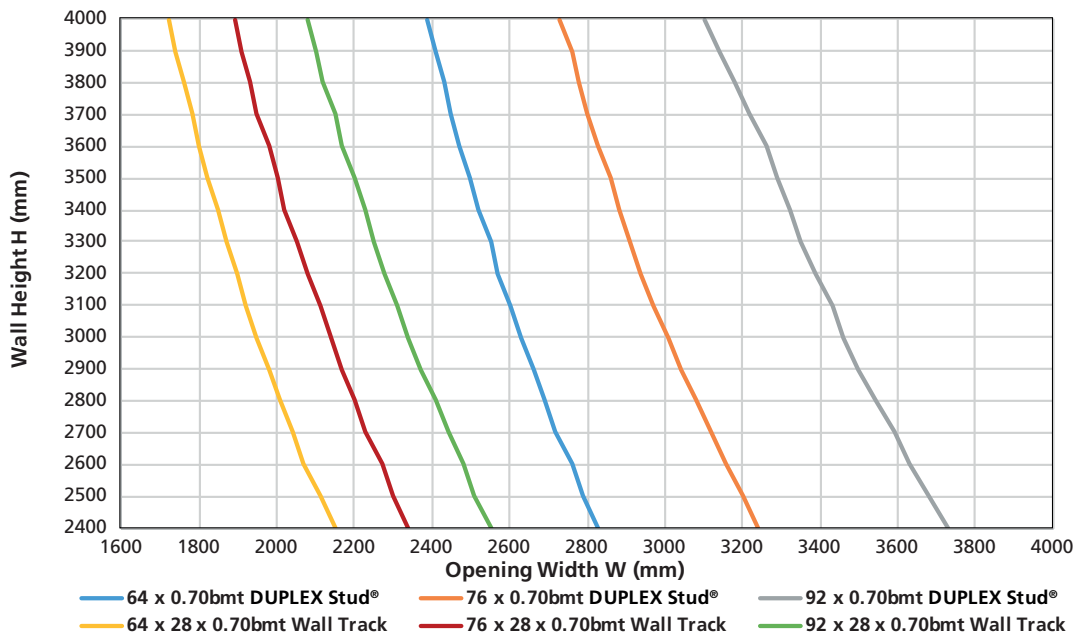

# OTHER RONDO WALL FRAMING SOLUTIONS

Rondo steel wall framing systems provide a durable, practical and lightweight structure for internal plasterboard walls to create attractive spaces within buildings, or external wall systems to provide direct support of the exterior cladding and interior linings.

### STEEL STUD DRYWALL FRAMING SYSTEM:

Light-weight steel stud and track drywall framing for internal plasterboard wall systems and specific external wall applications by Rondo Design.

### MAXIframe® EXTERNAL WALL FRAMING SYSTEM :

Offering a more cost-effective solution and greater performance capacities than traditional external wall framing construction methods.

### QUIET STUD® ACOUSTIC WALL FRAMING SYSTEM:

Its unique design delivers a more acoustic efficient wall system than a normal steel stud, and has a smaller footprint than alternative staggered stud installations.

### SHAFTWALL ONE-WAY ERECTED WALL SYSTEM:

Suitable for both fire-rated and sound-rated applications, the wall system is designed to encase lift shafts, stairwells and service ducting in low and high-rise construction areas.

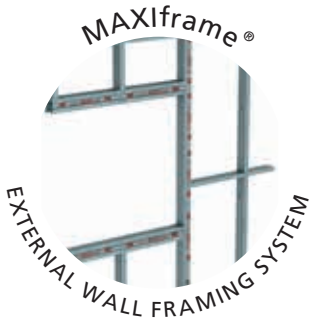

# RONDO OFFICES

**AUSTRALIA: RONDO BUILDING SERVICES PTY LTD**  
CUSTOMER SERVICE HOTLINE: 1300-36-RONDO (1300-36-7663)

**NEW SOUTH WALES**

57-87 Lockwood Road Erskine Park NSW 2759  
(PO Box 324 St Marys NSW 1790)  
phone: 61-2-9912 7300 fax: 61-2-9912 7310

*email: nsw@rondo.com.au*

**VICTORIA**

1 Columbia Court Dandenong South VIC 3175  
(Private Bag 23 Mulgrave VIC 3170)  
phone: 61-3-8561 2222 fax: 61-3-8561 2266

*email: vic@rondo.com.au*

**QUEENSLAND**

13 Binary Street Yatala QLD 4207  
(PO Box 6006 Yatala QLD 4207)  
phone: 61-7-3442 6400 fax: 61-7-3442 6427

*email: qld@rondo.com.au*

**SOUTH AUSTRALIA**

39 George Street Green Fields SA 5107  
phone: 61-8-8256 5900 fax: 61-8-8256 5922

*email: sa@rondo.com.au*

**WESTERN AUSTRALIA**

15 Glassford Road Kewdale WA 6105  
(PO Box 168 Cloverdale WA 6985)  
phone: 61-8-9251 9400 fax: 61-8-9251 9414

*email: wa@rondo.com.au*

**HEAD OFFICE**

57-87 Lockwood Road Erskine Park NSW 2759  
(PO Box 324 St Marys NSW 1790)  
phone: 61-2-9912 7300 fax: 61-2-9912 7310

*email: rondo@rondo.com.au*

**EXPORT** phone: 60-1-2386 1860 fax: 60-3-5636 0711

*email: export@rondo.com.au*

**NEW ZEALAND: RONDO BUILDING SERVICES PTY LTD**  
FREE CALL: 0800-0800-RONDO (0800-0800-76)  
[www.rondo.co.nz](http://www.rondo.co.nz)

**AUCKLAND**

117 Captain Springs Road Onehunga  
Auckland 1061  
(PO Box 12464 Penrose Auckland 1642)  
phone: 64-9-636 5110 fax: 64-9-636 5111

*email: rondo.newzealand@rondo.co.nz*

**CHRISTCHURCH**

106 F Carmen Road Hornby Christchurch 8042  
phone: 64-3-421 7840 fax: 64-9-636 5111

**MALAYSIA: RONDO METAL SYSTEMS SDN BHD**  
Lot 606, off Jalan SS13/1K  
47500 Subang Jaya Selangor  
phone: 60-3-5614 9888 fax: 60-3-5636 0711  
[www.rondo.asia](http://www.rondo.asia)

*email: rondo.malaysia@rondo.com.my*

**UAE: RONDO METAL PRODUCTS SDN BHD**  
Al Saraya Avenue Building Al Garhoud Dubai UAE  
(PO Box 14424 Dubai UAE)  
phone: 971-505-511-893

**INDIA: RONDO METAL SYSTEMS PVT LTD**  
phone: 91-808-098-1901  
[www.rondo.co.in](http://www.rondo.co.in)

*email: rondo.india@rondo.co.in*

**RONDO®**

[www.rondoglobal.com](http://www.rondoglobal.com)

**RONDO**<sup>®</sup>  
www.rondoglobal.com

we're behind the best buildings



SCAN & EMAIL ME