



Yale Catalogue





Coming Soon Yale YDM7220 Smart Lock

The Yale YDM7220 smart lock is a smart and extremely convenient solutions for your home. You can have all the various access option to enter your home either via fingerprint scan, personalized PIN code, RFID key tag or simply via your phone.



Trusted every day

Smart Lock



- MORTISE SMART LOCK
- RIM SMART LOCK
- DEADBOLT SMART LOCK
- SMART HOME ACCESS SOLUTIONS

Yale delivers a premium digital locking solution with flexible control and peace of mind. Your lock is controllable from anywhere in the world, when connected to a home automation hub!

YMI70 Mortise Smart Lock



Product Specification		
Product Dimension	Front	71.4 (D) x 77 (W) x 397.4 (H) mm
	Back	78 (D) x 77 (W) x 396.7 (H) mm
Access Credential	Keypad (PIN Code)	Available
	RFID Card	Available
	Fingerprint	Available
	Mechanical key	Available
	Maximum no. of users	User PIN code: Up to 30 / User Card: Up to 40 User Fingerprint: up to 40, One time code: only 1
	Compatible (Optional)	BLE, Z-Wave, Zigbee
Locking Device	Mortise Lock type	Available
Installation	Backset	70mm
	Door Thickness	40mm-65mm
	Battery	Alkaline (AA Size x 4)
Unit Price :		RM3,299.00

Key Features

- Fingerprint
- **** PIN Code
- RFID Card
- Built-in Yale Link Pack Bluetooth
- Mechanical Key Override

Additional Features

- Voice Guide**
The voice guide is offered that let you know the operation status how to set each features, mode for easier and more convenient use.
- Automatic Locking**
Automatic Locking The Yale DDL series automatically locks the door after checking it is properly closed.
- Alarm (Break/ Damage)**
80db alarm goes off if anyone attempts to damage the lock or force door open.
- Fake PIN code**
To prevent the PIN code from being exposed, it allows you to enter FAKE numbers before or after entering your PIN code.
- Low Battery and Emergency Power**
Low battery warning with alarm and LED. When the batteries are completely discharged, you can easily supply emergency power to the lock with the standard 9V battery.
- Remote Control (Optional)**
Remote control type is also available. Wireless Floating ID technology is adopted and works up to 50m.
- Bluetooth Module (Optional)**
Bluetooth communication module allows lock to communicate and be controlled via a Smart Phone (within Bluetooth range of the lock) using the Yale Link Apps.
- App Link Apps (Optional)**
Works with Yale Link Apps to access your lock remotely (To access Yale Link Apps function, user would need Yale Wifi Bridge and Yale Bluetooth Module available under Accessory Section).

YDM7116 Mortise Smart Lock



Product Specification		
Product Dimension	Front	40.18 (D) x 68 (W) x 340 (H) mm
	Back	36 (D) x 72 (W) x 344 (H) mm
Access Credential	Keypad (PIN Code)	Available
	RFID Card	Available
	Fingerprint	Available
	Mechanical key	Available
	Remote Control	Optional
	Maximum no. of users	User PIN code: Up to 30 / User Fingerprint: Up to 20 One time code: only 1
	Compatible (Optional)	BLE, Z-Wave, Zigbee
Locking Device	Mortise Lock type	Available
Installation	Backset	60mm/70mm
	Door Thickness	40-95mm
	Battery	Alkaline (AA Size x 4)
Unit Price:		RM2,549.00

Key Features

- Fingerprint
- **** PIN Code
- RFID Card
- Mechanical Key Override

Additional Features

- Voice Guide**
The voice guide is offered that let you know the operation status how to set each features, mode for easier and more convenient use.
- Automatic Locking**
Automatic Locking The Yale DDL series automatically locks the door after checking it is properly closed.
- Anti-Panic Egress**
For convenience and emergency, the door is automatically unlocked whenever the inner lever handle is used. Also, safe handle will protect you from any break-in attempts.
- Alarm (Break / Damage)**
80db alarm goes off if anyone attempts to damage the lock or force door open.
- Fake PIN code**
To prevent the PIN code from being exposed, it allows you to enter FAKE numbers before or after entering your PIN code.
- Low Battery and Emergency Power**
Low battery warning with alarm and LED. When the batteries are completely discharged, you can easily supply emergency power to the lock with the standard 9V battery.
- Remote Control (Optional)**
Remote control type is also available. Wireless Floating ID technology is adopted and works up to 50m.
- Bluetooth Module (Optional)**
Bluetooth communication module allows lock to communicate and be controlled via a Smart Phone (within Bluetooth range of the lock) using the Yale Link Apps.
- App Link Apps (Optional)**
Works with Yale Link Apps to access your lock remotely (To access Yale Link Apps function, user would need Yale Wifi Bridge and Yale Bluetooth Module available under Accessory Section).

YMF40+ Mortise Smart Lock



Product Specification		
Product Dimension	Front	25 (D) X 66 (W) X 320 (H) mm
	Back	31 (D) X 66 (W) X 320 (H) mm
Access Credential	Keypad (PIN Code)	Available
	RFID Card	N/A
	Fingerprint	Available
	Mechanical key	Available
	Remote Control	Optional
	Maximum no. of users	User PIN code: Up to 30 / User Fingerprint: Up to 20 One time code: only 1
Compatible (Optional)	BLE, Z-Wave, Zigbee	
Locking Device	Mortise Lock type	Available
	Backset	60mm
Installation	Door Thickness	40-65mm
	Battery	Alkaline (AA Size x 4)
	Unit Price: RM2,449.00	

Key Features

- Fingerprint
- **** PIN Code
- Mechanical Key Override

Additional Features

- Voice Guide**
The voice guide is offered that let you know the operation status how to set each features, mode for easier and more convenient use.
- Automatic Locking**
The Yale series automatically locks the door after checking it is properly closed. (Manual operation is also available.)
- Alarm (Break-in / Damage/ Fire)**
80dB alarm goes off if any one attempts to damage the lock or force the door open, or if the lock detects over 55°C.
- Fake PIN code**
To prevent the PIN code from being exposed, it allows you to enter FAKE numbers before or after entering your PIN code.
- Low Battery and Emergency Power**
It warns in case of low battery with alarm and LED. When the batteries are completely discharged, you can easily supply emergency power to the lock with a standard 9V battery.
- Operation Status Notification**
Whenever any operation is made, the keypad informs you what is happened through different alignment of the numbers.
- Remote Control (Optional)**
Remote control type is also available. Wireless Floating ID technology is adopted and works up to 50m.
- Bluetooth Module (Optional)**
Bluetooth communication module allows lock to communicate and be controlled via a Smart Phone (within Bluetooth range of the lock) using the Yale Link Apps.
- App Link Apps (Optional)**
Works with Yale Link Apps to access your lock remotely (To access Yale Link Apps function, user would need Yale Wifi Bridge and Yale Bluetooth Module available under Accessory Section)

YDM4109+ Mortise Smart Lock



Product Specification		
Product Dimension	Front	28.5 (D) X 68.6 (W) X 320.7 (H) mm
	Back	37 (D) x 72.8 (W) x 306.6 (H) mm
Access Credential	Keypad (PIN Code)	Available
	RFID Card	N/A
	Fingerprint	Available
	Mechanical key	Available
	Remote Control	Optional
	Maximum no. of users	User PIN code: Up to 30 / User Fingerprint: Up to 20 One time code: only 1
Compatible (Optional)	BLE, Z-Wave, Zigbee	
Locking Device	Mortise Lock type	Available
	Backset	60mm
Installation	Door Thickness	40-65mm
	Battery	Alkaline (AA Size x 4)
	Unit Price: RM2,399.00	

Key Features

- Fingerprint
- **** PIN Code
- Mechanical Key Override

Additional Features

- Voice Guide**
The voice guide is offered that let you know the operation status how to set each features, mode for easier and more convenient use.
- Automatic Locking**
The Yale series automatically locks the door after checking it is properly closed. (Manual operation is also available.)
- Anti-Panic Egress**
For convenience and in case of emergency, the door is automatically unlock whenever the inner lever handle is used. The safe handle will protect from any break-in attempts.
- Alarm (Break-in / Damage)**
80dB alarm goes off if any one attempts to damage the lock or force the door open, or if the lock detects.
- Fake PIN code**
To prevent the PIN code from being exposed, it allows you to enter FAKE numbers before or after entering your PIN code.
- Low Battery and Emergency Power**
It warns in case of low battery with alarm and LED. When the batteries are completely discharged, you can easily supply emergency power to the lock with a standard 9V battery.
- Operation Status Notification**
Whenever any operation is made, the keypad informs you what is happened through different alignment of the numbers.
- Remote Control (Optional)**
Remote control type is also available. Wireless Floating ID technology is adopted and works up to 50m.
- Bluetooth Module (Optional)**
Bluetooth communication module allows lock to communicate and be controlled via a Smart Phone (within Bluetooth range of the lock) using the Yale Link Apps.
- App Link Apps (Optional)**
Works with Yale Link Apps to access your lock remotely (To access Yale Link Apps function, user would need Yale Wifi Bridge and Yale Bluetooth Module available under Accessory Section)

YMF30+ Mortise Smart Lock



Product Specification		
Product Dimension	Front	25 (D) x 66 (W) x 320 (H) mm
	Back	31 (D) x 66 (W) x 31 (H) mm
Access Credential	Keypad (PIN Code)	Available
	RFID Card	Available
	Fingerprint	N/A
	Mechanical key	Available
	Remote Control	Optional
	Maximum no. of users	User PIN code: Up to 30 User Card: Up to 40 One time code: only 1
Compatible (Optional)	BLE, Z-Wave, Zigbee	
Locking Device	Mortise Lock type	Available
	Backset	60mm/70mm
Installation	Door Thickness	40-65mm
	Battery	Alkaline (AA Size x 4)
Unit Price:		RM2,159.00

Additional Features

- Voice Guide**
Whenever any operation is made, the keypad informs you what is happened though different alignment of the numbers.
- Automatic Locking**
The Yale series automatically locks the door after checking it is properly closed. (Manual operation is also available.)
- Anti-Panic Egress**
For convenience and emergency, the door is automatically unlocked whenever the inner lever handle is used. Also, safe handle will protect you from any break-in attempts.
- Alarm (Break-in / Damage)**
80dB alarm goes off if any one attempts to damage the lock or force the door open, or if the lock detects over 55°C.
- Fake PIN code**
To prevent the PIN code from being exposed, it allows you to enter FAKE numbers before or after entering your PIN code.
- Low Battery and Emergency Power**
It warns in case of low battery with alarm and LED. When the batteries are completely discharged, you can easily supply emergency power to the lock with a standard 9V battery.
- Operation Status Notification**
Whenever any operation is made, the keypad informs you what is happened through different alignment of the numbers.
- Remote Control (Optional)**
Remote control type is also available. Wireless Floating ID technology is adopted and works up to 50m.
- Bluetooth Module (Optional)**
Bluetooth communication module allows lock to communicate and be controlled via a Smart Phone (within Bluetooth range of the lock) using the Yale Link Apps.
- App Link Apps (Optional)**
Works with Yale Link Apps to access your lock remotely (To access Yale Link Apps function, user would need Yale Wifi Bridge and Yale Bluetooth Module available under Accessory Section)

Key Features

**** PIN Code

Mechanical Key Override

YDM3109+ Mortise Smart Lock



Product Specification		
Product Dimension	Front	27 (D) x 68.6 (W) x 306.6 (H) mm
	Back	37 (D) x 72.8 (W) x 306.6 (H) mm
Access Credential	Keypad (PIN Code)	Available
	RFID Card	Available
	Fingerprint	N/A
	Mechanical key	Available
	Remote Control	Optional
	Maximum no. of users	User PIN code: Up to 30 / User Card: Up to 40 One time code: only 1
Compatible (Optional)	BLE, Z-Wave, Zigbee	
Locking Device	Mortise Lock type	Available
	Backset	60mm
Installation	Door Thickness	40-65mm
	Battery	Alkaline (AA Size x 4)
	Unit Price:	

Additional Features

- Voice Guide**
Whenever any operation is made, the keypad informs you what is happened though different alignment of the numbers.
- Automatic Locking**
Yale Digital Door Lock series automatically locks a door after checking it is properly closed. (Manual operation is also available.)
- Anti-Panic Egress**
For convenience and in case of emergency, the door is automatically unlocked whenever the inner lever handle is used. The safe handle will protect from any break-in attempts.
- Alarm (Break / Damage)**
80dB alarm goes off if anyone attempts to damage the lock or force the door open, or the lock detects over 60°C.
- Fake PIN code**
To prevent the PIN code from being exposed, it allows you to enter FAKE numbers before or after entering your PIN code.
- Low Battery and Emergency Power**
It warns in case of low battery with alarm and LED. When the batteries are completely discharged, you can easily supply emergency power to the lock with a standard 9V battery.
- Operation Status Notification**
Whenever any operation is made, the keypad informs you what is happened through different alignment of the numbers.
- Remote Control (Optional)**
Remote control type is also available. Wireless Floating ID technology is adopted and works up to 50m.
- Bluetooth Module (Optional)**
Bluetooth communication module allows lock to communicate and be controlled via a Smart Phone (within Bluetooth range of the lock) using the Yale Link Apps.
- App Link Apps (Optional)**
Works with Yale Link Apps to access your lock remotely (To access Yale Link Apps function, user would need Yale Wifi Bridge and Yale Bluetooth Module available under Accessory Section)

Key Features

**** PIN Code

RFID Cards

Mechanical Key Override

YDR41 Rim Smart Lock



Front View



Back View



Product Specification		
Product Dimension	Front	20 (D) x 64.6 (W) x 160.5 (H)
	Back	36.4 (D) x 162.2 (W) x 87 (H)
Access Credential	Keypad (PIN Code)	Available
	RFID Card	N/A
	Fingerprint	Available
	Mechanical key	N/A
	Remote Control	Optional
	Maximum no. of users	User PIN code: Up to 30 User Fingerprint: up to 20 One time code: only 1
	Compatible (Optional)	BLE, Z-Wave, Zigbee
Locking Device	RIM Lock type	Available
Installation	Backset	50 / 60mm
	Door Thickness	30~57mm
	Battery	Alkaline (AA Size x 4)

Unit Price: RM1,599.00

Key Features

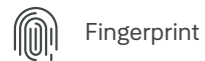

Fingerprint

**** PIN Code

Additional Features



Voice Guide Feature

The voice guided operating manual for easier and more convenient use.



Automatic Locking

The Yale series automatically locks the door after checking it is properly closed. (Manual operation is also available.)



Alarm (Break / Damage)

Audible alarm sounds if attempting to forcibly remove outside lock from door.



Fake PIN Code

To prevent the PIN code from being exposed, it allows you to enter FAKE numbers before or after entering your PIN code.



Low Battery and Emergency Power

When battery power is low, the Low Battery Warning indicator flashes RED. If battery power is completely lost, use the 9Volt battery override. Try to use 9V battery override apply 9V battery, in either direction, to terminals below the touchscreen for backup power option. Wake up the lock and enter your code to unlock the door.



Operation Status Notification

Whenever any operation is made, the keypad informs you what is happened through different alignment of the numbers.



Remote Control (Optional)

Remote control type is also available. Wireless Floating ID technology is adopted and works up to 50m.



Bluetooth Module (Optional)

Bluetooth communication module allows lock to communicate and be controlled via a Smart Phone (within Bluetooth range of the lock) using the Yale Link Apps.



App Link Apps (Optional)

Works with Yale Link Apps to access your lock remotely (To access Yale Link Apps function, user would need Yale Wifi Bridge and Yale Bluetooth Module available under Accessory Section)

YDR4110+ Rim Smart Lock



Front View



Back View



Product Specification		
Product Dimension	Front	20 (D) X 64.6 (W) X 160.5 (H) mm
	Back	36.4 (D) X 142.1 (W) X 87.1 (H) mm
Access Credential	Keypad (PIN Code)	Available
	RFID Card	N/A
	Fingerprint	Available
	Mechanical key	N/A
	Remote Control	Optional
	Maximum no. of users	User PIN code: Up to 30 User Fingerprint: Up to 20 One Time Code: Only 1
	Compatible (Optional)	BLE, Z-Wave, Zigbee
Locking Device	RIM Lock type	Available
Installation	Backset	60mm~70mm
	Door Thickness	40-65mm
	Battery	Alkaline (AA Size x 4)

Unit Price: RM1,299.00

Key Features



Fingerprint

**** PIN Code

Additional Features



Voice Guide

The Voice Guide lets you know the operation status and how to set each feature and mode.



Automatic Locking

Yale Digital Door Lock series automatically locks a door after checking that it is properly closed. (Manual operation is also available.)



Alarm (Break / Damage / Fire)

80dB alarm goes off if anyone attempts to damage the lock or force the door open or the lock detects heat over 60°C.



Low battery and Emergency Power

It warns in case of low battery with alarm and LED. When the batteries are completely discharged, you can easily supply emergency power to the lock with a standard 9V battery.



Operation status notification

Whenever any operation is made, the keypad informs you what is happened through different alignment of the numbers.



Remote Control (Optional)

Remote control type is also available. Wireless Floating ID technology is adopted and works up to 50m.



Bluetooth Module (Optional)

Bluetooth communication module allows lock to communicate and be controlled via a Smart Phone (within Bluetooth range of the lock) using the Yale Link Apps.



App Link Apps (Optional)

Works with Yale Link Apps to access your lock remotely (To access Yale Link Apps function, user would need Yale Wifi Bridge and Yale Bluetooth Module available under Accessory Section)

YDR343 Rim Smart Lock



Front View



Back View



Product Specification		
Product Dimension	Front	12 (D) x 67.9 (W) x 178.8 (H) mm
	Back	48.8 (D) x 77.5 (W) x 100.5 (H) mm
Access Credential	Keypad (PIN Code)	Available
	RFID Card	Available
	Fingerprint	N/A
	Mechanical key	N/A
	Remote Control	Optional
	Maximum no. of users	User PIN code: 1 User Card: Up to 40
	Compatible (Optional)	N/A
Locking Device	RIM Lock type	Available
	Backset	70~90mm
Installation	Door Thickness	35-55mm
	Battery	Alkaline (AA Size x 4)

Unit Price: RM1,099.00

Key Features



RFID Cards

**** PIN Code

Additional Features



Automatic Locking

The Yale series automatically locks the door after checking it is properly closed. (Manual operation is also available).



Alarm (Break / Damage)

80dB alarm goes off if anyone attempts to damage the lock or force the door open, or if the lock detects over 60°.



Fake PIN Code

To prevent the PIN code from being exposed, it allows you to enter Fake numbers before or after entering your PIN Code.



Low Battery and Emergency Power

It warns in case of low battery with alarm and LED. When the batteries are completely discharged, you can easily supply emergency power to the lock with the standard 9v battery.



Remove Control (Optional)

You can use the Remote Control by installing the applicable remote control module. This option may not available depending on your country or local dealer.

YDD424+ Deadbolt Smart Lock

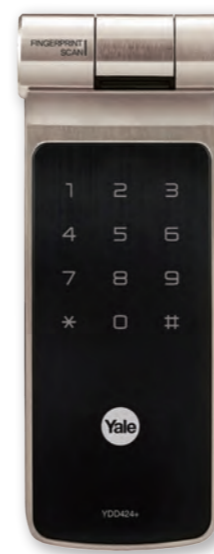

Front View



Back View



Product Specification		
Product Dimension	Front	31.5 (D) X 66 (W) X 176 (H) mm
	Back	35 (D) X 70 (W) X 170 (H) mm
Access Credential	Keypad (PIN Code)	Available
	RFID Card	N/A
	Fingerprint	Available
	Mechanical key	Available
	Remote Control	Optional
	Maximum no. of users	User PIN code: 30 User Fingerprint: Up to 20
	Compatible (Optional)	BLE, Z-Wave, Zigbee
Locking Device	Deadbolt Lock type	Available
	Backset	60/70mm
Installation	Door Thickness	45~57mm
	Battery	Alkaline (AA Size x 4)

Unit Price: RM1,999.00

Key Features

**** PIN Code



Card Key



Bluetooth, Z-Wave, Zigbee



Mechanical Key



Work with App

Additional Features



Voice Guide

The voice guide is offered that let you know the operation status how to set each features, made for easier and more convenient use.



Automatic Locking

The Yale DDL series automatically locks the door after checking it is properly closed.



Alarm (Break / Damage)

80dB alarm goes off if anyone attempts to damage the lock or force the door open.



Fake PIN Code

To prevent the PIN code from being exposed, it allows you to enter Fake numbers before or after entering your PIN Code.



Low Battery and Emergency Power

Low Battery warning with alarm and LED. When the batteries are completely discharged, you can easily supply emergency power to the lock with the standard 9v battery.



Remote Control (Optional)

Remote control type is also available. Wireless Floating ID technology is adopted and works up to 50m.



Bluetooth Module (Optional)

Bluetooth communication module allows lock to communicate and be controlled via a Smart Phone (within Bluetooth range of the lock) using the Yale Link Apps.



App Link Apps (Optional)

Works with Yale Link Apps to access your lock remotely (To access Yale Link Apps function, user would need Yale Wifi Bridge and Yale Bluetooth Module available under Accessory Section)

YDD324 Deadbolt Smart Lock



Front View



Back View



Product Specification		
Product Dimension	Front	27 (D) X 66 (W) X 162 (H) mm
	Back	35 (D) X 70 (W) X 170 (H) mm
Access Credential	Keypad (PIN Code)	Available
	RFID Card	Available
	Fingerprint	N/A
	Mechanical key	Available
	Remote Control	Optional
	Maximum no. of users	User PIN code: 1 User Card: Up to 40
	Compatible (Optional)	N/A
Locking Device	Deadbolt Lock type	Available
	Backset	60 / 70mm
Installation	Door Thickness	45~57mm
	Battery	Alkaline (AA Size x 4)

Unit Price: RM1,199.00

Key Features

**** PIN Code



Card Key



Mechanical Key

Additional Features



Automatic Locking

The Yale series automatically locks the door after checking it is properly closed. (Manual operation is also available.)



Alarm (Break / Damage)

80dB alarm goes off if anyone attempts to damage the lock or force the door open, or if the lock detects over 60°



Fake PIN Code

To prevent the PIN code from being exposed, it allows you to enter Fake numbers before or after entering your PIN Code.



Low Battery and Emergency Power

It warns in case of low battery with alarm and LED. When the batteries are completely discharged, you can easily supply emergency power to the lock with the standard 9v battery.



Remove Control (Optional)

Remove control type is also available. Wireless floating ID technology is adopted and works up to 50m.

YDF40 Deadbolt Smart Lock



Front View



Back View



Product Specification		
Product Dimension	Front	31.5 (D) x 66 (W) x 176 (H)
	Back	35 (D) x 70 (W) x 170 (H)
Access Credential	Keypad (PIN Code)	Available
	RFID Card	N/A
	Fingerprint	Available
	Mechanical key	N/A
	Remote Control	Optional
	Maximum no. of users	User PIN code: Up to 30, User Fingerprint: up to 20, One time code: only 1
	Compatible (Optional)	N/A
Locking Device	Deadbolt Lock type	Available
	Backset	60 / 70mm
Installation	Door Thickness	30~57mm
	Battery	Alkaline (AA Size x 4)

Unit Price: RM1,399.00

Key Features



Fingerprint

**** PIN Code

Additional Features



Voice Guide

The voice guide is offered that let you know the operation status how to set each features, mode for easier and more convenient use.



Automatic Locking

The Yale series automatically locks the door after checking it is properly closed. (Manual operation is also available.)



Alarm (Break-in / Damage)

Audible alarm sounds if attempting to forcibly remove outside lock from door.



Fake PIN code

To prevent the PIN code from being exposed, it allows you to enter FAKE numbers before or after entering your PIN code.



Low Battery and Emergency Power

When battery power is low, the Low Battery Warning indicator flashes RED. If battery power is completely lost, use the 9Volt battery override. Try to use 9V battery override apply 9V battery, in either direction, to terminals below the touchscreen for backup power option. Wake up the lock and enter your code to unlock the door.



Operation Status Notification

Whenever any operation is made, the keypad informs you what is happened through different alignment of the numbers.



Remote Control (Optional)

Remote control type is also available. Wireless Floating ID technology is adopted and works up to 50m.



Bluetooth Module (Optional)

Bluetooth communication module allows lock to communicate and be controlled via a Smart Phone (within Bluetooth range of the lock) using the Yale Link Apps.



App Link Apps (Optional)

Works with Yale Link Apps to access your lock remotely (To access Yale Link Apps function, user would need Yale Wifi Bridge and Yale Bluetooth Module available under Accessory Section)

YDR50G Metal Gate Smart Lock



Front View



Back View



Product Specification		
Product Dimension	Front	28 (D) x 63.5 (W) x 176 (H)
	Back	40 (D) x 77 (W) x 220 (H)
Access Credential	Keypad (PIN Code)	Available
	RFID Card	Available
	Fingerprint	Available
	Mechanical key	Available
	Maximum no. of users	User PIN code: Up to 30 / User Card: Up to 40 User Fingerprint: up to 20 One time code: only 1
Compatible (Optional)	BLE, Z-Wave, Zigbee	
Locking Device	Rim Lock type	Available
Installation	Battery	Alkaline (AA Size x 4)

Unit Price: RM1,899.00

Key Features



Fingerprint

**** PIN Code



RFID Card



Mechanical Key Override

Additional Features



Voice Guide
The voice guide is offered that let you know the operation status how to set each features, mode for easier and more convenient use.



Automatic Locking
Yale Digital Door Lock series automatically locks a door after checking that it is properly closed. (Manual operation is also available.)



Alarm (Break / Damage / Fire)
80dB alarm goes off if anyone attempts to damage the lock or force the door open or the lock detects heat over 60°C.



Fake PIN code
To prevent the PIN code from being exposed, it allows you to enter FAKE numbers before or after entering your PIN code.



Low Battery and Emergency Power
Low battery warning with alarm and LED. When the batteries are completely discharged, you can easily supply emergency power to the lock with the standard 9V battery.



Operation Status Notification
Whenever any operation is made, the keypad informs you what is happened through different alignment of the numbers.



Remote Control (Optional)
Remote control type is also available. Wireless Floating ID technology is adopted and works up to 50m.



Bluetooth Module (Optional)
Bluetooth communication module allows lock to communicate and be controlled via a Smart Phone (within Bluetooth range of the lock) using the Yale Link Apps.



App Link Apps (Optional)
Works with Yale Link Apps to access your lock remotely (To access Yale Link Apps function, user would need Yale Wifi Bridge and Yale Bluetooth Module available under Accessory Section)

YDR30G Metal Gate Smart Lock

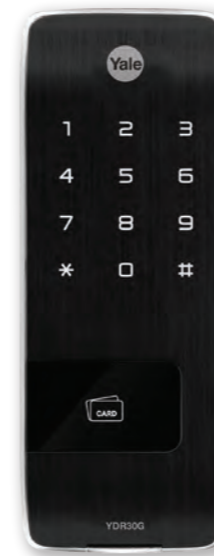

Front View



Back View



Product Specification		
Product Dimension	Front	21 (D) x 70 (W) x 183 (H) mm
	Back	40 (D) x 77 (W) x 220 (H) mm
Access Credential	Keypad (PIN Code)	Available
	RFID Card	Available
	Fingerprint	N/A
	Mechanical key	Available
	Remote Control	Optional
	Maximum no. of users	User PIN code: Up to 30 / User Card: Up to 40 One time code: only 1
Compatible (Optional)	BLE, Z-Wave, Zigbee	
Locking Device	RIM Lock type	Available
Installation	Battery	Alkaline (AA Size x 4)

Unit Price: RM1,599.00

Key Features



RFID Card

**** PIN Code



Mechanical Key Override

Additional Features



Automatic Locking
The Yale series automatically locks the door after checking it is properly closed. (Manual operation is also available.)



Alarm (Break / Damage)
80dB alarm goes off if anyone attempts to damage the lock or force the door open.



Fake PIN Code
To prevent the PIN code from being exposed, it allows you to enter Fake numbers before or after entering your PIN code.



Low Battery and Emergency Power
It warns in case of low battery with alarm and LED. When the batteries are completely discharged, you can easily supply emergency power to the lock with the standard 9V battery.



Operation Status Notification
Whenever any operation is made, the keypad informs you what is happened through different alignment of the numbers.



Remote Control (Optional)
Remote control type is also available. Wireless Floating ID technology is adopted and works up to 50m.



Bluetooth Module (Optional)
Bluetooth communication module allows lock to communicate and be controlled via a Smart Phone (within Bluetooth range of the lock) using the Yale Link Apps.

Yale Smart Keypad

Yale

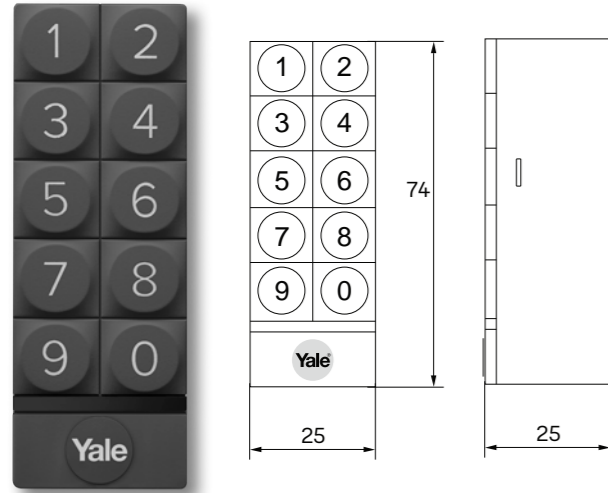

Product Specification	
Product Dimension	73.3 (H) x 25 (W) x 25 (D) mm
Communication	Bluetooth V4.2
Battery Life	Estimated 3 months
Operating Temperature	-17-50c
Operating Humidity	0-90%
Finish	Black nylon plastic
Number of Key codes	220 PIN codes
Unit Price:	RM439.00

Key Features

- Create and send guests unique entry codes with Yale Access
- Installs in minutes on the outside of your home - nothing to wire, battery powered
- The Yale Smart Keypad works with all models of the Yale Smart Lock

Smart Lock Pro

Yale

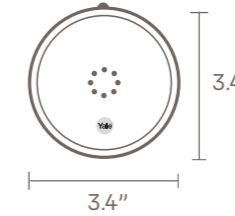

Product Specification

Battery type	AA
Door Material	Timber
Warranty / Guarantee	2 Years
Battery life	1 Year
Audit trails	Yes
Lock Type	Deadbolt
Low Battery Indicator	Yes
Colour	Silver
Unit Price	RM1299.00

Key Features

- Voice Guide**
Enable Siri to control or check status of your front door.
- Premium Design**
Yale Smart Lock Pro is built with premium components and features LED lights and chime tones to complement your lock movement.
- Automatic Locking**
Auto Unlock knows when you arrive and unlocks the door as you approach. Never fumble for keys again.
- Be Sure Its Locked**
Only Smart Lock Pro has DoorSense™, a sensor that tells you if your door is securely closed and locked.
- Control Guest Access**
Send guest secure keys to friends, family or people you trust instantly, all from the Yale Access app.
- Upgrade Your Existing Lock**
Simply attach to your existing deadbolt from the inside of your door. Your existing keys will still working.
- Total Control**
Lock and unlock your door, grant keyless access and keep track of who comes and goes, all from your Yale Access App.
- Apple HomeKit Enabled**
Control your lock with your voice with an iPhone, AppleWatch, Apple TV, HomePod or iPad.
- Complete**
Includes Yale Connect WiFi Bridge which connects your lock to the cloud, so you get full voice and remote access functionality right out of the box.

Yale Link Wifi Bridge Smart Home Technology



Yale Bridge Solution

Yale Link is an integrated security solution that controls the opening and closing of doors of the Yale Smart Lock through smartphone application and provides real-time monitoring of the status of smart door locks.



Product Specification

Warranty / Guarantee | 1 Years
Unit Price | RM429.00

Yale Link App



"Between You and Your World, Yale Link"

Upgrade your life style with innovative 'Yale Link' service, developed by the number 1 digital doorlock brand YALE. Now, you can easily unlock your digital doorlock from anywhere with your smartphone. No need to remember password, no need to carry cards anymore.

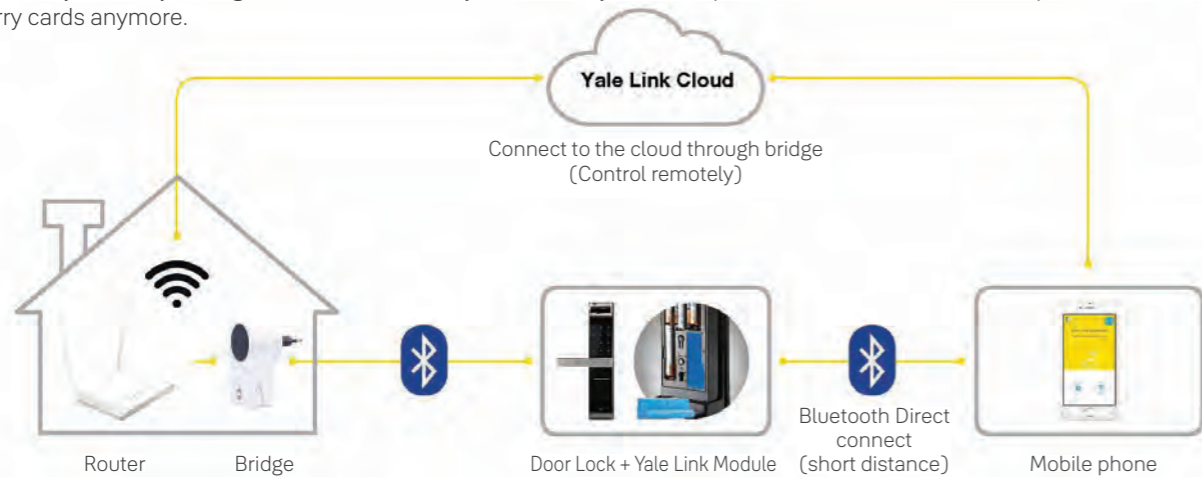

Features of Yale Link & Wifi Bridge



Smart Push Notification
 Receive notification to unlock your door with Yale Link app



Control from anywhere
 Control your smart lock remotely via Yale Wifi Bridge



Real-time push notification
 Notify you whenever someone unlocked using fingerprint/pin/remote control card/Bluetooth key



Event history
 You can check out your lock's event history in the Yale Link app



Alert notification
 Receive a notification when the lock is jammed or alarm is armed.



Door lock Setting
 User friendly interface to personalise the lock settings and register new users.

Accessories



YRC100
 Remote Control - Big

Product Specification
 Remote Control works on all digital door lock
Warranty / Guarantee | 1 Years
Unit Price | RM250.00



YRC10
 Remote Control - Small

Product Specification
Warranty / Guarantee | 1 Years
Body / Case Material | Plastic
Unit Price | RM280.00



YALE HA Module
 Remote Control Entry - Orange

Product Specification
Warranty / Guarantee | 1 Years
Unit Price | RM250.00



Zwave Module

Product Specification
Warranty / Guarantee | 1 Years
Unit Price | RM350.00



Zigbee Module (EMEA)

Product Specification
Warranty / Guarantee | 1 Years
Unit Price | RM305.00





Yale Link Pack (Bluetooth ver2.0)

Product Specification
Warranty / Guarantee | 1 Years
Unit Price | RM200.00

Smart Lock Specification Chart



Product Name	Product Type	Yale Link App						
			YRC100 Remote Control - Big	YRC10 Remote Control - Small	YALE HA Module Remote Control Entry - Orange	Zwave Module	Zigbee Module (EMEA)	Yale Link Pack (Bluetooth ver2.0)
YMI70	Smart Mortise Lock	✓	✓	✓	✓	✓	✓	✓
YDM7116	Smart Mortise Lock	✓	✓	✓	✓	✓	✓	✓
YMF40+	Smart Mortise Lock	✓	✓	✓	✓	✓	✓	✓
YDM4109B+	Smart Mortise Lock	✓	✓	✓	✓	✓	✓	✓
YMF30+	Smart Mortise Lock	✓	✓	✓	✓	✓	✓	✓
YDM3109+	Smart Mortise Lock	✓	✓	✓	✓	✓	✓	✓
YDR41	Smart Rim Lock	✓	✓	✓	✓	✓	✓	✓
YDR4110+	Smart Rim Lock	✓	✓	✓	✓	✓	✓	✓
YDR343	Digital Rim Lock		✓	✓	✓			
YDD424+	Smart Rim Lock	✓	✓	✓	✓	✓	✓	✓
YDD324	Digital Deadbolt Lock		✓	✓	✓			
YDF40	Digital Deadbolt Lock		✓	✓	✓			
YDR50G	Smart Rim Lock - Metal Gate	✓	✓	✓		✓	✓	✓
YDR30G	Smart Rim Lock - Metal Gate	✓	✓	✓	✓	✓	✓	✓

Entrance Lockset



- KEY IN KNOB
- KEY IN LEVER
- DEADBOLT

Yale offers a vast choice of door lock-sets all doors in your home. We have designed a comprehensive range of door handle-sets for your entrance doors, door lever-sets and knob-sets for your internal doors. These door lock-sets are in exceptionally high quality, with variety of functions, dimensions, finishes and styles to suit most security and decor needs.

VCA5120 Series Key-In-Knob



VCA5120 Series

is the economic choice for standard residential purpose. Recommended for use on internal doors.



VCA5125 US32D
Cylinder Knobset

Finishes :



Knob Style	Series Name	Function Code	Finish Code	Backset Code	Strike Code	Unit Price
VCA	512	1 - Passage Or Closet	US11 - Antique Copper	B60 = 60mm B70 = 70mm	S70 Strike Length = 70mm (Standard Offering)	RM54.00
			US32D - Satin Stainless Steel			RM48.00
		2 - Privacy, Bedroom or Bathroom	US11 - Antique Copper			RM59.00
			US32D - Satin Stainless Steel			RM54.00
		5 - Storeroom or Closet	US11 - Antique Copper			RM73.00
			US32D - Satin Stainless Steel			RM65.00
		7 - Entrance	US11 - Antique Copper			RM66.00
			US32D - Satin Stainless Steel			RM60.00

Product Specification

- Standard** | ANSI / BHMA A 156.2 2003
- Testing Cycles** | Guaranteed for 175,000 cycles
- Materials** |
 - Chassis : Steel
 - Latch and Bolt : Zinc
 - Strike : Stainless Steel / Steel
 - Knob : Stainless Steel / Brass
 - Rose : Stainless Steel / Brass
- Backset** | 60mm / 70mm
- Door Thickness** | 35 ~ 50 mm
- Function** | Entrance, Bathroom, Passage, Storeroom
- Cylinder** | Solid brass 5-pin tumble cylinder plug with zinc housing
- No of Keys** | 3 pcs of nickel plated brass key
- Quantity / Ctn** | 24 pcs

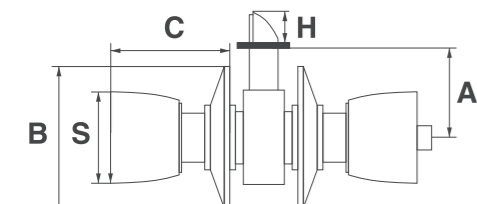
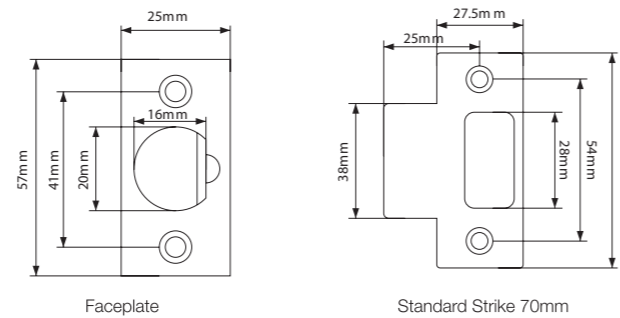

Product Dimension

Model No.	Dimension (mm)				
	A	B	C	H	S
VCA	60/70	65	60-68	11.5	53.5

VCA5130 Series Key-In-Knob



VCA5130 Series

Standard Duty Cylindrical Knobset



VCA5137 US32D
Cylinder Knobset

Finishes :



Knob Style	Series Name	Function Code	Finish Code	Backset Code	Strike Code	Unit Price
VCA	513	7 - Entrance	US11 - Antique Copper	B60 = 60mm B70 = 70mm	S70 Strike Length = 70mm (Standard Offering)	RM115.00
			US32D - Satin Stainless Steel			RM95.00

Product Specification

- Testing Cycles** | Guaranteed for 100,000 cycles
- Materials** |
 - Chassis : Steel
 - Latch and Bolt : Zinc
 - Strike : Stainless Steel / Steel
 - Knob : Stainless Steel / Brass
 - Rose : Stainless Steel / Brass
- Backset** | 60mm / 70mm
- Door Thickness** | 35 ~ 50mm
- Function** | Entrance
- Cylinder** | Solid brass 5-pin tumbler cylinder
- No of Keys** | 3 pcs of nickel plated brass key
- Quantity / Ctn** | 24 pcs

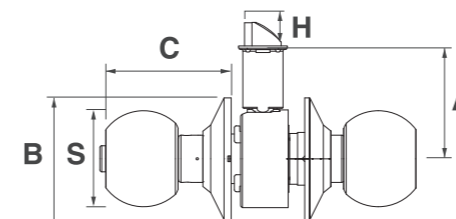
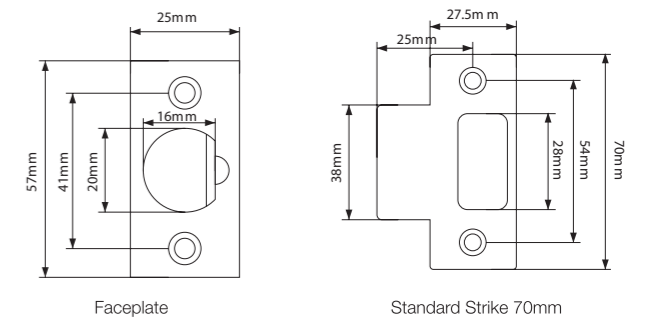

Product Dimension

Model No.	Dimension (mm)				
	A	B	C	H	S
VCA	59	65	67	12.5	51

VCA5230 Series Key-In-Knob



VCA5230 Series

Standard Duty Cylindrical Knobset



VCA5237 US32D
Cylinder Knobset

Finishes :



Knob Style	Series Name	Function Code	Finish Code	Backset Code		Strike Code	Unit Price
VCA	523	7 - Entrance	US11 - Antique Copper	B60 = 60mm	B70 = 70mm	S70 Strike Length = 70mm (Standard Offering)	RM130.00
			US32D - Satin Stainless Steel				RM103.00

Product Specification

- Standard** | ANSI / BHMA A 156.2 2003 Grade 3
- Testing Cycles** | Guaranteed for 200,000 cycles
- Materials** | - Chassis : Steel
- Latch and Bolt : Zinc
- Strike : Stainless Steel / Steel
- Knob : Stainless Steel / Brass
- Rose : Stainless Steel / Brass
- Backset** | 60mm / 70mm
- Door Thickness** | 35 ~ 50mm
- Function** | Entrance
- Cylinder** | Solid brass 5-pin tumble cylinder
- No of Keys** | 3 pcs of nickel plated brass key
- Quantity / Ctn** | 24 pcs

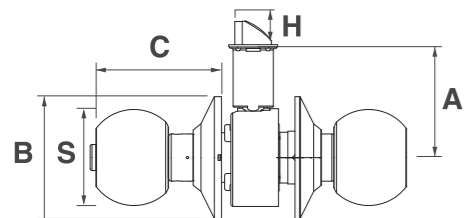
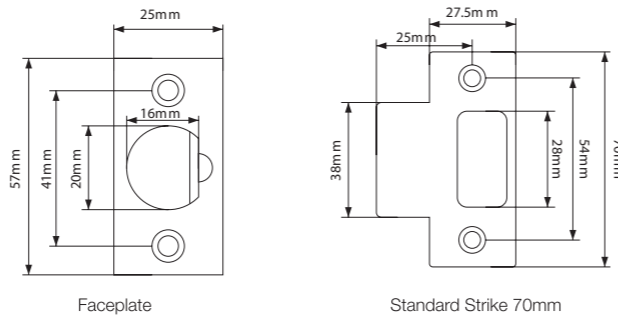

Product Dimension

Model No.	Dimension (mm)				
	A	B	C	H	S
VCA	59	65	67	12.5	51

Functions Key-In-Knob



1 Passage or Closet

- Latchbolt by either knob

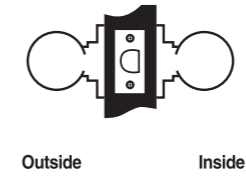

2 Privacy, Bedroom or Bath

- Both knobs locked or unlocked by push-button inside
- Push-button automatically releases when inside knob is turned or door is closed
- Outside knob unlocked with a coin insert. Inside knob always free

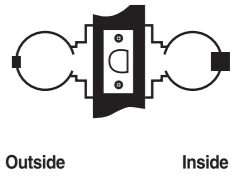

3 Patio or Privacy

- Deadlocking latch bolt for exit doors with limited entry
- Both knobs locked or unlocked by push-button inside
- Push-button automatically releases when inside knob is turned or door is closed
- Inside knob always free

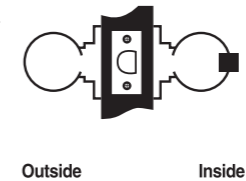

5 Storeroom or Closet

- Open from the outside only when the key is turned
- Inside knob always free

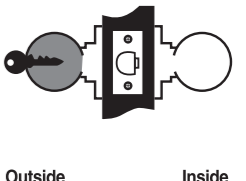

7 Entrance

- Both knobs locked or unlocked by key outside or push-button inside
- For 5800 series, outside locked or unlocked by key outside or push-button inside
- Inside knob always free

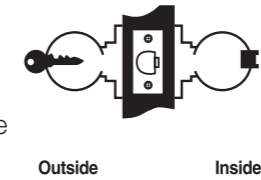

8 Classroom

- Outside locked or unlocked by key outside
- Inside knob always free

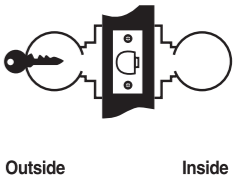

21 Communicating

- Key in either knobs or unlocks its knob only

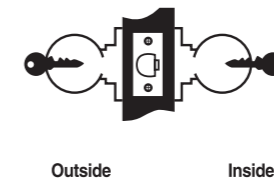

28 Exit

- Deadlocking latchbolt for two communicating or exit doors where one-side operation is required
- Inside knob always free
- Blank rose outside

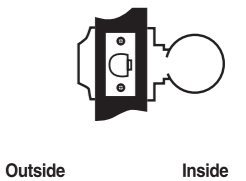

35 Communicating

- Deadlocking latchbolt for doors with a thickness of 35mm to 45mm only.
- Full turn of key locks or unlocks knob inside
- Blank rose outside

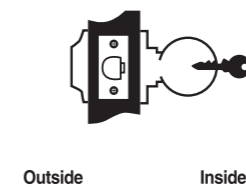

VCA4140 Essential Series Key-In-Knob



VCA4147 US32D
Cylinder Knobset

Finishes :



Knob Style	Series Name	Function Code	Finish Code	Backset Code		Strike Code	Unit Price
VCA	414	2 - Privacy, Bedroom or Bathroom	US11 - Antique Copper	B60 = 60mm	B70 = 70mm	S70 Strike Length = 70mm (Standard Offering)	RM50.00
			US32D - Satin Stainless Steel				RM44.00
		7 - Entrance	US11 - Antique Copper				RM51.00
			US32D - Satin Stainless Steel				RM46.00

Product Specification

- Testing Cycles** | Guaranteed for 100,000 cycles
- Materials** | Stainless Steel (Anti Rust)
- Backset** | 60mm/70mm
- Door Thickness** | 35 ~ 50mm
- Function** | Privacy, Entrance
- Cylinder** | Hollow brass plug & aluminium housing
- No of Keys** | 3 pcs of nickel plated brass key
- Quantity / Ctn** | 24 pcs

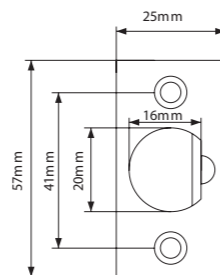

Faceplate

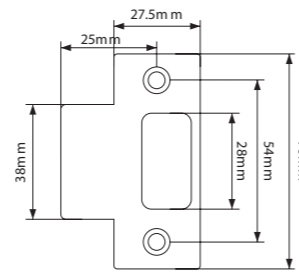

Standard Strike 70mm

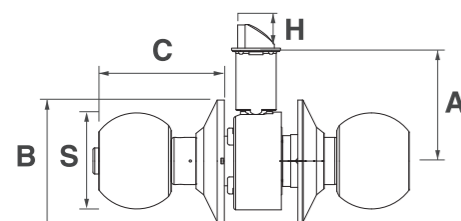

Product Dimension

Model No.	Dimension (mm)				
	A	B	C	H	S
VCA	70	65	70	22	53

VL5340 Series Key-In-Lever

VL5340 Series Medium Duty Tubular Leverset

VL5300 is easy to install, recommended as the economic choice for standard residential applications.



VL5342 US15
Tubular Leverset

Finishes :



Knob Style	Series Name	Function Code	Finish Code	Backset Code		Strike Code	Unit Price
VL	534	2 - Privacy, Bedroom or Bathroom	US15- Satin Nickel	B60 = 60mm	B70 = 70mm	S70 Strike Length = 70mm (Standard Offering)	RM91.00
		7 - Entrance					RM106.00

Product Specification

- Standard** | ANSI / BHMA A 156.2 2003 Grade 3
- Testing Cycles** | Guaranteed for 200,000 cycles
- Materials** | -Chassis : Steel
-Latch and Bolt : Zinc
-Strike : Stainless Steel / Steel
-Knob : Stainless Steel / Brass
-Rose : Stainless Steel / Brass
- Backset** | 60mm / 70mm
- Door Thickness** | 35 ~ 50mm
- Function** | Residential and light duty commercial or institution use
- Cylinder** | Solid brass 5-pin tumble cylinder
- No of Keys** | 3 pcs of nickel plated brass key
- Quantity / Ctn** | 24 pcs

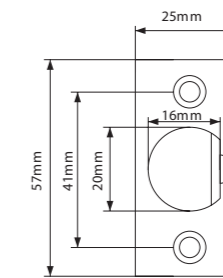

Faceplate

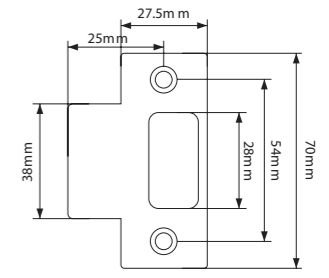

Standard Strike 70mm

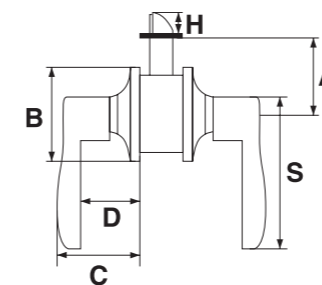

Product Dimension

Model No.	Lever Style	Dimension (mm)					
		A	B	C	D	H	S
VL534	2	60/70	65	61	41	12.5	118
	7	60/70	65	61	41	12.5	118

Functions Key-In-Lever



1 Passage or Closet

- Both levers always free

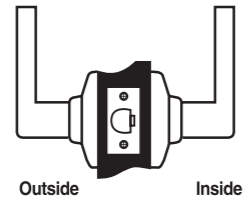

2 Privacy, Bedroom or Bath

- Both levers locked or unlocked by push-button inside
- Push-button automatically release when inside lever is turned or door is closed
- Outside lever unlocked with a coin insert
- Inside lever always free

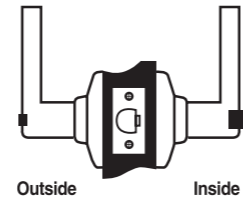

7 Entrance

- Both levers locked or unlocked by key outside or push-button inside

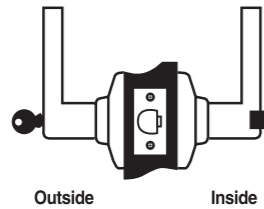

VL4420 Essential Series Key-In-Lever



VL4427 US15

Tubular Leverset

Finishes :

US15

Knob Style	Series Name	Function Code	Finish Code	Backset Code	Strike Code	Unit Price
VL	442	2 - Privacy, Bedroom or Bathroom	US15 -Satin Nickel	B60 = 60mm B70 = 70mm	S70 Strike Length = 70mm (Standard Offering)	RM59.00
		7 - Entrance				RM67.00

Product Specification

- Testing Cycles** | Guaranteed for 100,000 cycles
- Materials** | -Chassis : Steel
-Lever : Aluminium, Rose SS304
-Latch and Bolt : Solid Brass
-Lockset : Zinc Alloy
- Backset** | 60mm / 70mm
- Door Thickness** | 30 ~ 50mm
- Function** | Residential and light duty commercial or institution use
- Cylinder** | Hollow brass plug & aluminium housing
- No of Keys** | 3 pcs of nickel plated brass key
- Quantity / Ctn** | 24 pcs

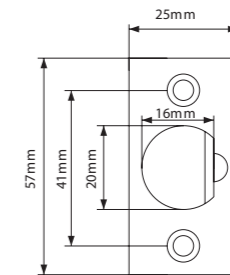

Faceplate

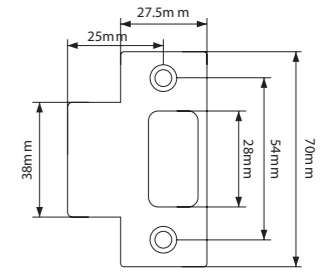

Standard Strike 70mm

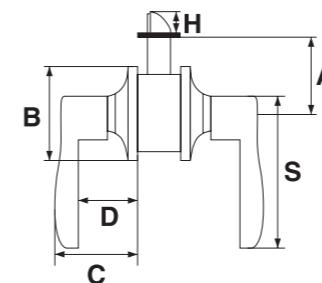

Product Dimension

Model No.	Lever Style	Dimension (mm)					
		A	B	C	D	H	S
VL442	2	60/70	65	61	41	12.5	118
	7	60/70	65	61	41	12.5	118

VL4460 Essential Series Key-In-Lever



VL4462 US15
Tubular Leverset

Finishes :
US15

Knob Style	Series Name	Function Code	Finish Code	Backset Code	Strike Code	Unit Price
VL	446	2 - Privacy, Bedroom or Bathroom	US15 - Satin Nickel	B60 = 60mm B70 = 70mm	S70 Strike Length = 70mm (Standard Offering)	RM67.00
		7 - Entrance				RM73.00

Product Specification

Testing Cycles | Guaranteed for 100,000 cycles

Materials | -Chassis :
-Latch and Bolt : Solid Brass
-Lockset : Zinc Alloy

Backset | 60mm / 70mm

Door Thickness | 30 ~ 50mm

Function | Residential and light duty commercial or institution use

Cylinder | Hollow brass plug & aluminium housing

No of Keys | 3 pcs of nickel plated brass key

Quantity / Ctn | 24 pcs

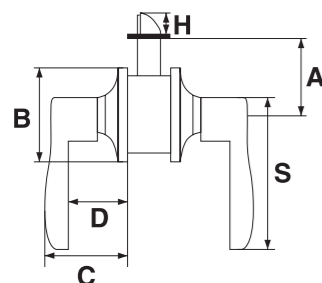
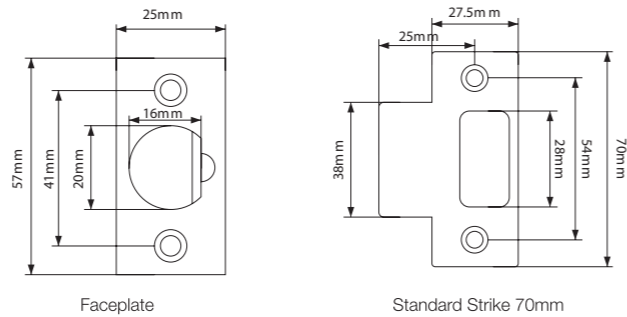

Product Dimension

Model No.	Lever Style	Dimension (mm)					
		A	B	C	D	H	S
VL446	2	60/70	65	67	45	13	120
	7	60/70	65	67	45	13	120

VL4440 Essential Series Key-In-Lever



VL4447 US15
Tubular Leverset

Finishes :
US15

Knob Style	Series Name	Function Code	Finish Code	Backset Code	Strike Code	Unit Price
VL	444	2 - Privacy, Bedroom or Bathroom	US15 - Satin Nickel	B60 = 60mm B70 = 70mm	S70 Strike Length = 70mm (Standard Offering)	RM59.00
		7 - Entrance				RM67.00

Product Specification

Testing Cycles | Guaranteed for 100,000 cycles

Materials | -Chassis : Steel
-Latch and Bolt : Zinc
-Strike : Stainless Steel / Steel
-Knob : Stainless Steel / Brass
-Rose : Stainless Steel / Brass

Backset | 60mm / 70mm

Door Thickness | 35 ~ 50mm

Function | Residential and light duty commercial or institution use

Cylinder | Solid brass 5-pin tumble cylinder

No of Keys | 3 pcs of nickel plated brass key

Quantity / Ctn | 24 pcs

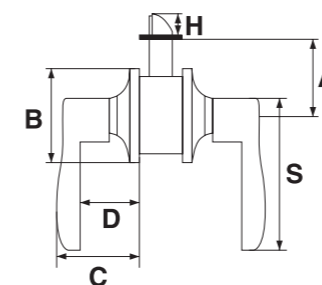
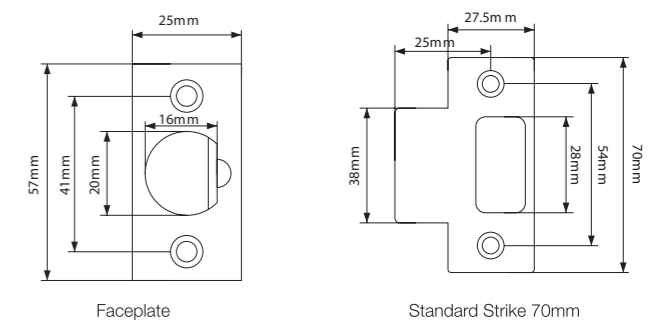

Product Dimension

Model No.	Lever Style	Dimension (mm)					
		A	B	C	D	H	S
VL444	2	60/70	65	61	41	12.5	118
	7	60/70	65	61	41	12.5	118

V8100 Series Standard Duty Deadbolt



V8100 Series

is an economical durable deadbolt, ideal for use as an auxiliary lock on residential applications.



V8101 US32D
One Side Deadbolt (Internal Function)

Finishes :

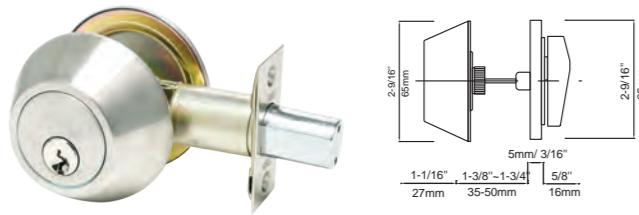

V8111 US32D
Single Cylinder with Thumb Turn

Finishes :

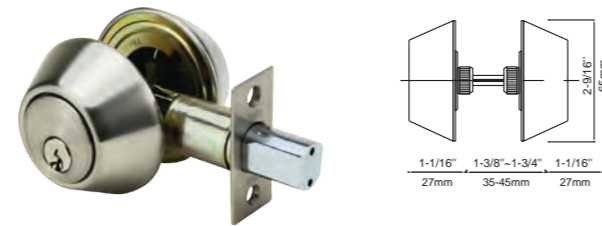

V8121 US11
Double Cylinder Deadbolt

Finishes :



Series Name	Function Code	Finish Code	Backset Code	Strike Code	Door Thickness	Unit Price
V81	01	US11 - Antique Copper	Adjustable backset of 60mm or 70mm	Standard Rectangle Strike Length = 57mm	T1 = 35mm - 50mm	RM53.00
		US32D - Satin Stainless Steel				RM47.00
	11	US11 - Antique Copper				RM70.00
		US32D - Satin Stainless Steel				RM65.00
	21	US11 - Antique Copper				RM84.00
		US32D - Satin Stainless Steel				RM78.00

Product Specification

- Standard** | ANSI / BHMA A 156.2 2001
- Testing Cycles** | 100,000 cycles tested
- Materials** | - Chassis : Steel
- Latch and Bolt : Zinc
- Cylinder Housing : Steel
- Round Plate : Brass
- Backset** | 60mm / 70mm
- Door Thickness** | 35 ~ 50mm
- Function** | Residential applications.
- Anti-Sawing Insert** | Hardened Steel
- Cylinder** | Solid brass 5-pin tumble cylinder
- No of Keys** | 3 pcs of nickel plated brass key
- Quantity / Ctn** | 24 pcs

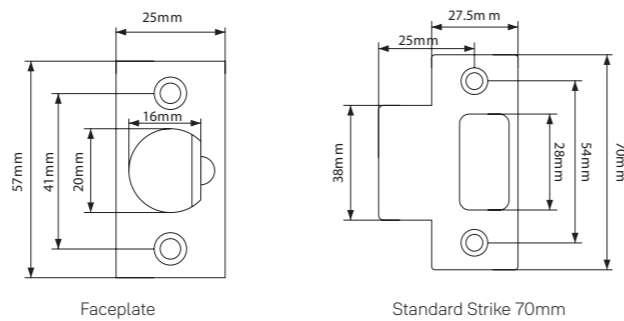

VYED100 Essential Series Standard Duty Deadbolt



VYED1001 US32D
Single Cylinder with Thumb Turn

Finishes :



VYED1002 US32D
Double Cylinder

Finishes :



Series Name	Cylindrical Type	Finish Code	Backset Code	Strike Code	Door Thickness	Unit Price
VYED	1001	US11 - Antique Copper	Adjustable backset of 60mm or 70mm	Standard Rectangle Strike Length = 57mm	T1 = 35mm - 50mm	RM55.00
		US32D - Satin Stainless Steel				RM50.00
	1002	US11 - Antique Copper				RM63.00
		US32D - Satin Stainless Steel				RM58.00

Product Specification

VYED1001

- Testing Cycles** | 100,000 cycles tested
- Materials** | - Chassis : Steel
- Latch and Bolt : Zinc
- Cylinder Housing : Steel
- Round Plate : Brass
- Backset** | 60mm / 70mm
- Door Thickness** | 35 ~ 50mm
- Function** | Residential applications.
- Anti-Sawing Insert** | Hardened Steel
- Cylinder** | Solid brass 5-pin tumble cylinder
- No of Keys** | 3 pcs of nickel plated brass key
- Quantity / Ctn** | 30 pcs

VYED1002

- Testing Cycles** | 100,000 cycles tested
- Materials** | - Cylinder Plug : Hollow Brass
- Cylinder Housing : Aluminium
- Backset** | 60mm / 70mm
- Door Thickness** | 35 ~ 50mm
- Function** | Residential applications.
- Anti-Sawing Insert** | Hardened Steel
- Cylinder** | Solid brass 5-pin tumble cylinder
- No of Keys** | 3 pcs of nickel plated brass key
- Quantity / Ctn** | 30 pcs

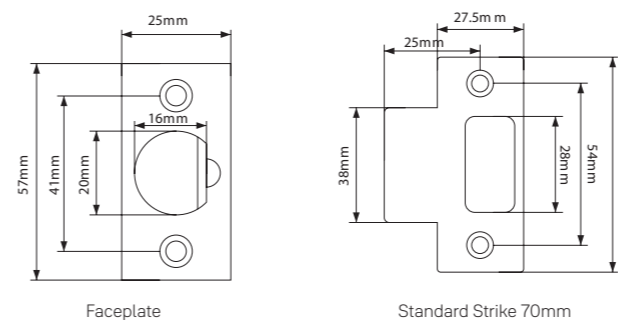

YEC70 Essential Series Profile Cylinder



YEC70CT
Thumbturn Cylinder

Finishes :
US15

Series Name	Cylindrical Type	Types	Finish Code	Unit Price
YEC	70mm	US15	US15 - Satin Nickle	RM55.00

Product Specification and Features

- EN1303 tested
- Brass plug with Aluminium housing for durable application
- 5 pins construction
- 3 x Solid Brass Keys
- Available in 60mm (30/30mm) and 70mm (35mm/35mm) to cover most common door thickness (35mm - 48mm)
- Available only with key differ and packed with the Yale Mortise Lock

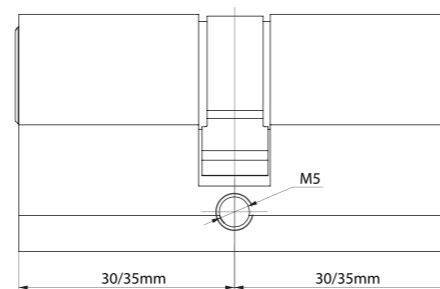

YEM Essential Series Mortise Set



YEM6085 US15
Mortise Entrance

Finishes :
US15

Series Name	Cylindrical Type	Finish Code	Backset Code	Unit Price
YEM	6085	US15 - Satin Nickle	Adjustable backset of 60mm	RM69.00

Product Specification and Features

- Tested to EN12209
- Durable Brass Latchbolt
- Solid Steel Deadbolt
- Sintered Steel Floorer
- Forend and Strike available in Steel or Stainless Steel
- Easy reversible latchbolt for non-handed installation
- Double throw dedbold for extra security
- Through bolt fixing holes for use with bolt through fixed lever on rose
- Close case design

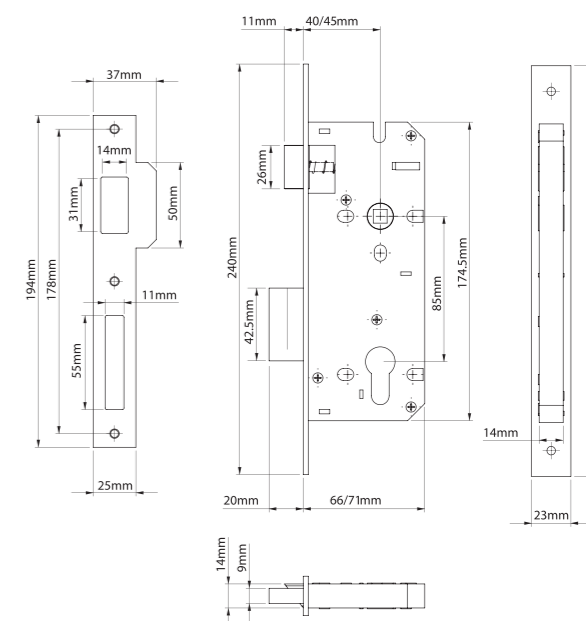

Door Accessories



- DOOR CHAIN
- DOOR GUARD
- DOOR VIEWER

Yale door accessories are easy to install and use, and cater to a range of low budgets with additional door security needs.

- Yale door guards have been designed with a ball locking mechanism to match the plate and holder, to provide additional security to stop unauthorized entry to your home even if the door lock has been picked.
- Yale door chains allow for safe caller identification before the full release of the door.
- Yale high quality door viewers providing a wide angle of view without straining your eyes and protect yourself and your family from potential burglary and intruders.

Door Accessories



V18L US26D

Door Guard

Finishes :

US11  US26 

Product Specification

Ball locking mechanism to match plate and holder

For use on wooden door

Materials | Zinc Alloy

Quantity / Ctn | 40 pcs

Unit Price | RM39.00

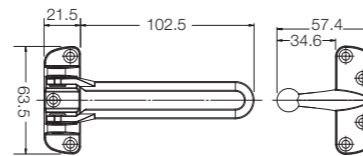

V1037 US26D

Door Chain

Finishes :

US11  US26 

Product Specification

For use on wooden door

Materials | Steel

Quantity / Ctn | 40 pcs

Unit Price | RM22.00

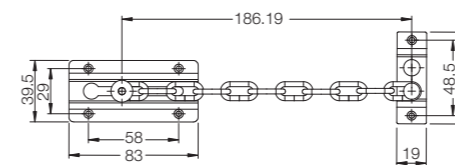

V0401A US26D

Door Viewer

Finishes :

US11  US15 

Product Specification

For use on wooden door

Fit door thickness | 35 - 60 mm

Wide angle of view | 180°

Option view cover

Materials | Body : Brass
Lens : Plastic/Glass

Quantity / Ctn | 200 pcs

Unit Price | RM31.00 (US11)
RM28.00 (US15)

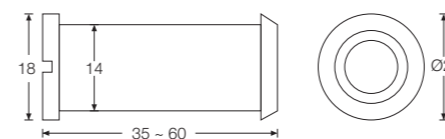

Door Closer



- DOOR CLOSER**

Yale offers a wide range of door closer with various closing forces for application on wood, metal or glass doors.

C-77EN Series Door Closer



C-77EN2 Door Closer

Finishes :
SB 

Product Specification

- Certification** | UL Listed.
Conform to UL228 & UL10C
- Passed Durability Test** | 100,000 cycles
-Easily adjustable arm height
-Max opening angle 105°
-Reversible (Left/Right hand fixing)
- Two speed valves** | -One to control closing speed from 105° to 15°
-Second to activate final latch from 15° to 0°
-Back check (BC) (Optional)
- Quantity / Ctn** | 10 pcs
- Function** | Fix Arm

Model No.	Dimension			Max. width of door (mm)	Max. weight of door (kg)	Arm type	Torque Max	Option features	Finish	Unit Price
	L	W	H							
EN2	182	53	60.5	850	40	Standard	18 NM	BC Backcheck	SB Silver	RM116.00

C-77EN Series Door Closer



C-77EN4 Door Closer

Finishes :
SB

Product Specification

Certification		UL Listed. Conform to UL228 & UL10C
Passed Durability Test		100,000 cycles -Easily adjustable arm height -Max opening angle 105° -Reversible (Left/Right hand fixing)
Two speed valves		-One to control closing speed from 105° to 15° -Second to activate final latch from 15° to 0° -Back check (BC) (Optional)
Quantity / Ctn		10 pcs

Model No.	Dimension			Max. width of door (mm)	Max. weight of door (kg)	Arm type	Torque Max	Option features	Finish	Unit Price
	L	W	H							
EN4	182	53	60.5	1100	65	Standard	37 Nm	BC Backcheck	SB Silver	RM127.00

YFS Series Floor Spring



YFS8003 Floor Spring

Finishes :
US32D

Product Specification and Features

- Tested to EN1154: Product performance standard
- Double action floor spring
- Cast iron body
- Dual valve adjusting, closing and latching speed
- Maximum opening angle in each direction of 130°
- Applicable for timber, glass and aluminum doors
- Power sizes 2, 3, 4
- Max. weight of door: 120kg

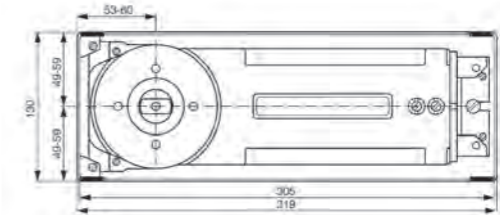

Product Information

Type and Door Weight

YFS 8003 Technical Info. & Function

	Size 2 (YFS8003-2)	Size 3 (YFS8003-3)	Size 4 (YFS8003-4)
Closing Force (Nm) 0°- 4°	15	20	25
Width of door (mm)	800	1000	1200
Weight of door (kg) Max	80	100	120
Max open angle	130°		
Hold open	90° or 115°		
Closing speed Adjustment	Speed 1	90° to 25°	
	Speed 2	25° to 0°	
Removeable spindle	Optional		
Applicable temperature	-20°C to 45°C		
Applicability	Wooden, glass & aluminium door etc. Left-open, right-open, single-side open or both side open.		
Weight (kg)	5.2		
Dimension of cement Box (mm)	Length	305	
	Width	108	
	Depth	41	
Passed durability test	500,000 cycles		

Patch Fitting



Corner Lock with Cylinder



P010
Patch Fitting

Finishes :
US32D

Product Specification

- Product Description** | Yale Bottom Door
Patch to suit Floor Springs
- Finish** | Satin Stainless Steel - US32D
Polished Stainless Steel - US32

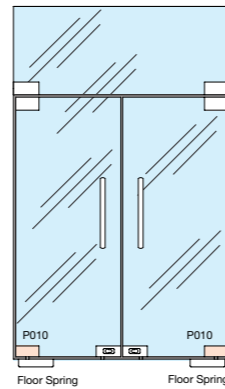

L010
Patch Fitting

Finishes :
US32D

Product Specification

- Product Description** | Yale Corner Lock suits
Euro Profile Cylinder
- Finish** | Satin Stainless Steel - US32D
Polished Stainless Steel - US32

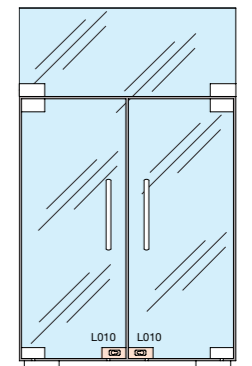
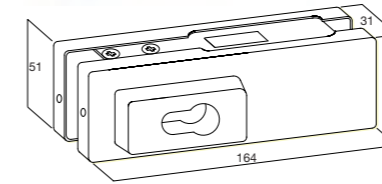

P020
Patch Fitting

Finishes :
US32D

Product Specification

- Product Description** | Yale Top Door
Patch to suit 15mm pivot
- Finish** | Satin Stainless Steel - US32D
Polished Stainless Steel - US32

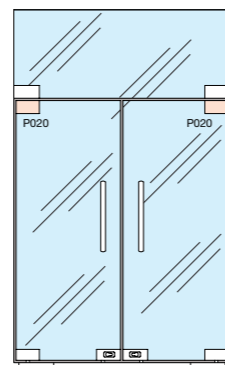
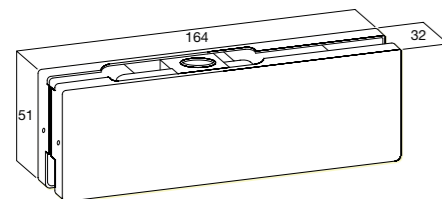

PadLock



- PADLOCK
- TRAVEL LOCK

It may seem like an impossible task to improve on an object that has already been a part of our lives for generations. But with new developments in design innovation, materials and changing end user needs, Yale applies new insights into production techniques to make its products as user-friendly and as secure as possible.

As the world changes, Yale locks evolve. Whether in extreme conditions, outdoor or indoor, the new Yale padlock range offers universally relevant locking solutions to survive years of use in all types of environments.

Y-120B Series Baron Padlock



Y120B/40/125/1

Body material	Brass/ Chrome Plated
Shackle material	Boron
No. of padlocks	1
No. of keys	3
Security grading	2
Corrosion rating	Indoor

Quantity / Ctn	Unit Price
1 pc pack - 72	RM63.00



Y120B/50/127/1

Body material	Brass/ Chrome Plated
Shackle material	Boron
No. of padlocks	1
No. of keys	3
Security grading	2
Corrosion rating	Indoor

Quantity / Ctn	Unit Price
1 pc pack - 36	RM97.00



Y120B/50/127/2

Body material	Brass/ Chrome Plated
Shackle material	Boron
No. of padlocks	1
No. of keys	3 Keys Each Blister
Security grading	2
Corrosion rating	Indoor

Quantity / Ctn	Unit Price
2 pcs pack - 24	RM187.00



Y120B/50/127/4

Body material	Brass/ Chrome Plated
Shackle material	Boron
No. of padlocks	1
No. of keys	4 Keys Each Blister
Security grading	2
Corrosion rating	Indoor

Quantity / Ctn	Unit Price
4 pcs pack - 12	RM374.00



Y120B/50/163/1

Body material	Brass/ Chrome Plated
Shackle material	Boron
No. of padlocks	1
No. of keys	3
Security grading	2
Corrosion rating	Indoor

Quantity / Ctn	Unit Price
1 pc pack - 36	RM104.00



Y120B/60/135/1

Body material	Brass/ Chrome Plated
Shackle material	Boron
No. of padlocks	1
No. of keys	3
Security grading	3
Corrosion rating	Indoor

Quantity / Ctn	Unit Price
1 pc pack - 24	RM123.00

Y150 Series Combination Padlock - General Security



Y150/30/125/1

Body material | Solid Brass/Natural
Shackle material | Steel
No. of padlocks | 1
No. of keys | 3
Corrosion rating | Indoor

Quantity / Ctn	Unit Price
1 pc pack - 120	RM44.00



Y150/40/130/1

Body material | Solid Brass/Natural
Shackle material | Steel
No. of padlocks | 1
No. of keys | 4
Corrosion rating | Indoor

Quantity / Ctn	Unit Price
1 pc pack - 72	RM60.00

Y150B Series Brass Combination Padlock



Y150B/30/125/1

Body material | Brass/
Clear Lacquer
Shackle material | Steel
No. of padlocks | 1
No. of keys | 0
Corrosion rating | Indoor

Quantity / Ctn	Unit Price
1 pc pack - 120	RM47.00



Y150B/40/130/1

Body material | Brass/
Clear Lacquer
Shackle material | Steel
No. of padlocks | 1
No. of keys | 0
Corrosion rating | Indoor

Quantity / Ctn	Unit Price
1 pc pack - 72	RM65.00

Y-120 Series Baron Padlock Matrix



New Part Number	Description	Qty keys Each Blister	Locking Points	Qty Pins	Body Width	Body Height	Body Depth	Shackle Diameter	Corrosion Resistance	Security Level On Packaging	EN12320 Result (CEN Rating)	Yale Internal Standard
120B/40/125/1	40mm Brass Padlock with Chrome Finish	3 pcs	Double Locking Brass latch	5 Pins	40	38.5	14	6	96 Hours	High	2	5
Y120B/50/127/1	50mm Brass Padlock with Chrome Finish	3 pcs	Double Locking Brass latch	5 Pins	50	47	17	7	96 Hours	High	2	6
Y120B/50/127/2	50mm Brass Padlocks with Chrome Finish pk2	3 pcs	Double Locking Brass latch	5 Pins	50	47	17	7	96 Hours	High	2	6
Y120B/50/127/4	50mm Brass Padlocks with Chrome Finish pk4	4 pcs	Double Locking Brass latch	5 Pins	50	47	17	7	96 Hours	High	2	6
Y120B/50/163/1	50mm Brass Padlock with Chrome Finish Long Shackle	3 pcs	Double Locking Brass latch	5 Pins	50	47	17	7	96 Hours	High	2	6
Y120B/60/135/1	60mm Brass Padlock with Chrome Finish	3 pcs	Double Locking Brass latch	5 Pins	60	53.6	18	10	96 Hours	High	3	6

Y150B Series Brass Combination Padlock Matrix

New Part Number	Description	Qty keys	Locking Points	Qty Pins	Body Width	Body Height	Body Depth	Shackle Diameter	Corrosion Resistance	Security Level On Packaging	EN12320 Result (CEN Rating)	Yale Internal Standard
Y150B/22/120/1	22mm Brass Combination Padlock	NA	Single Locking Zinc die cast latch	3 dial	22	33.2	10	3.18	96 Hours	Standard	-----	2
Y150B/22/120/2	22mm Brass Combination Padlocks pk 2	NA	Single Locking Zinc die cast latch	3 dial	22	33.2	10	3.18	96 Hours	Standard	-----	2
Y150B/30/125/1	30mm Brass Combination Padlock	NA	Single Locking Zinc die cast latch	3 dial	31.5	44.5	13	4.75	96 Hours	Standard	-----	2
Y150B/40/130/1	40mm Brass Combination Padlock	NA	Single Locking Zinc die cast latch	4 dial	40	50.4	14	6	96 Hours	Standard	-----	3

YE1 Series Essential Padlock

Yale



YE1/20/111/1 YE1/20/111/2 YE1/20/111/4

Body material | Brass/Natural
Shackle material | Chrome-plated hardened steel
No. of padlocks | 1
No. of keys | 3
Corrosion rating | Indoor

Quantity / Ctn	Unit Price
1 pc pack - 36	RM16.00
2 pcs pack - 36	RM31.00
4 pcs pack - 36	RM61.00



YE1/20/122/1

Body material | Brass/Natural
Shackle material | Chrome-plated hardened steel
No. of padlocks | 1
No. of keys | 3
Corrosion rating | Indoor

Quantity / Ctn	Unit Price
1 pc pack - 36	RM17.00



YE1/25/113/1 YE1/25/113/2

Body material | Solid Brass/Natural
Shackle material | Chrome-plated hardened steel
No. of padlocks | 1
No. of keys | 3
Corrosion rating | Indoor

Quantity / Ctn	Unit Price
1 pc pack - 36	RM19.00
2 pcs pack - 36	RM35.00



YE1/25/125/1

Body material | Solid Brass/Natural
Shackle material | Chrome-plated hardened steel
No. of padlocks | 1
No. of keys | 3
Corrosion rating | Indoor

Quantity / Ctn	Unit Price
1 pc pack - 36	RM20.00



YE1/30/115/1 YE1/30/115/2

Body material | Solid Brass/Natural
Shackle material | Chrome-plated hardened steel
No. of padlocks | 1
No. of keys | 3
Corrosion rating | Indoor

Quantity / Ctn	Unit Price
1 pc pack - 36	RM25.00
2 pcs pack - 36	RM48.00



YE1/30/132/1

Body material | Brass/Natural
Shackle material | Chrome-plated hardened steel
No. of padlocks | 1
No. of keys | 3
Corrosion rating | Indoor

Quantity / Ctn	Unit Price
1 pc pack - 36	RM27.00



YE1/30/147/1

Body material | Brass/Natural
Shackle material | Chrome-plated hardened steel
No. of padlocks | 1
No. of keys | 3
Corrosion rating | Indoor

Quantity / Ctn	Unit Price
1 pc pack - 36	RM29.00

YE1 Series Essential Padlock

Yale



YE1/40/122/1 YE1/40/122/2 YE1/40/122/4

Body material | Brass/Natural
Shackle material | Chrome-plated hardened steel
No. of padlocks | 1
No. of keys | 3
Corrosion rating | Indoor

Quantity / Ctn	Unit Price
1 pc pack - 36	RM34.00
2 pcs pack - 36	RM64.00
4 pcs pack - 36	RM125.00



YE1/40/140/1

Body material | Brass/Natural
Shackle material | Chrome-plated hardened steel
No. of padlocks | 1
No. of keys | 3
Corrosion rating | Indoor

Quantity / Ctn	Unit Price
1 pc pack - 36	RM35.00



YE1/40/152/1

Body material | Brass/Natural
Shackle material | Chrome-plated hardened steel
No. of padlocks | 1
No. of keys | 3
Corrosion rating | Indoor

Quantity / Ctn	Unit Price
1 pc pack - 24	RM36.00



YE1/50/126/1 YE1/50/126/2 YE1/50/126/4

Body material | Brass/Natural
Shackle material | Chrome-plated hardened steel
No. of padlocks | 1
No. of keys | 3
Corrosion rating | Indoor

Quantity / Ctn	Unit Price
1 pc pack - 24	RM50.00
2 pcs pack - 24	RM98.00
4 pcs pack - 12	RM193.00



YE1/50/166/1

Body material | Brass/Natural
Shackle material | Chrome-plated hardened steel
No. of padlocks | 1
No. of keys | 3
Corrosion rating | Indoor

Quantity / Ctn	Unit Price
1 pc pack - 24	RM51.00



YE1/60/132/1

Body material | Brass/Natural
Shackle material | Chrome-plated hardened steel
No. of padlocks | 1
No. of keys | 3
Corrosion rating | Indoor

Quantity / Ctn	Unit Price
1 pc pack - 24	RM77.00



YE1/70/137/1

Body material | Brass/Natural
Shackle material | Chrome-plated hardened steel
No. of padlocks | 1
No. of keys | 3
Corrosion rating | Indoor

Quantity / Ctn	Unit Price
1 pc pack - 24	RM129.00

YE1 Series Essential Brass Padlock Matrix

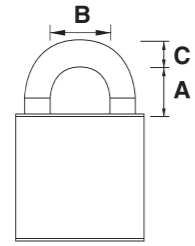

C - Shackle Diameter (mm)
 A - Clearance Height (mm)
 B - Clearance Width (mm)

Model no.	Brass Body Width (mm)	C	Standard Shackle		Long Shackle		Extra-long Shackle	
			Standard Shackle	Long Shackle	Long Shackle	Extra-long Shackle		
YE1/20	20	3	11	11	-	-	-	-
YE1/25	25	4	14	13	-	-	-	-
YE1/30	30	5	16	15	32	15	47	15
YE1/40	40	6	22	21	40	21	52	21
YE1/50	50	8	26	26	66	26	-	-
YE1/60	60	10	32	31	-	-	-	-

Travel Lock



YP2/23/128/1
 Multi Code Lock Round
Body material | Zinc
Shackle material | Steel
No. of padlocks | 1
No. of dials | 3

Quantity / Ctn	Unit Price
1 pc pack - 108	RM28.00



VIBRANT COLOURS

Easy identifiable luggage - a lock in a recognizable vibrant colour makes your luggage easy to find on the carousel.

Part No.	Color
YP2/23/128/1R	Red
YP2/23/128/1G	Grey
YP2/23/128/1Y	Yellow
YP2/23/128/1P	Pink
YP2/23/128/1B	Blue
YP2/23/128/1O	Orange
YP2/23/128/1E	Emerald



YP1/28/121/1
 Multi Code Lock
Body material | Zinc
Shackle material | Steel
No. of dials | 3

Quantity / Ctn	Unit Price
1 pc pack - 108	RM30.00



Part No.	Color
YP1/28/121/1R	Red
YP1/28/121/1G	Grey
YP1/28/121/1Y	Yellow
YP1/28/121/1P	Pink
YP1/28/121/1B	Blue
YP1/28/121/1O	Orange
YP1/28/121/1E	Emerald



YTP2/26/216/1
 Clip On Lock TSA
Body material | Zinc
Shackle material | Zinc
No. of dials | 3
TSA recognized | Yes
Indicates Inspection | No

Quantity / Ctn	Unit Price
1 pc pack - 108	RM53.00



Part No.	Color
YTP2/26/216/1R	Red
YTP2/26/216/1G	Grey
YTP2/26/216/1Y	Yellow

Safes



- SECURITY SAFE
- VALUE SAFE
- ELITE SAFE
- CASH BOX
- KEY BOX

At Yale we've been looking after people's homes and their favorite things for over two hundred years. We understand that the truest form of security is the freedom to enjoy living life to the full, without worry.

The New Yale Safe Collection has been designed to provide just that. As one of the world's best known, and preferred, leading lock brands we follow our mission to help consumers live more carefree lives. So we have combined the latest technologies and materials with centuries of experience to create safes that meet the most demanding requirements.

Security Safe Home Safe Box



Security Safe

Economic option of security digital safes for good burglary protection.

- Locking System** | 6 lever double - bitted override locking system
- Battery** | 4 x AA Size (1.5V x 4)
- Finishes** | Matt black faceplate
Powder coated interior
- Mounting** | Wall Mount
- Key System** | Key Override Function
- No of Key** | 2

YLB/200/EB1

Security Safe Laptop

- Exterior dimensions** | 200 (H) x 480 (W) x 350 (D) mm
- Interior dimensions** | 192 (H) x 475 (W) x 295 (D) mm
- Net weight** | 14kg
- Quantity / Ctn** | 1
- Unit Price** | RM1,100.00

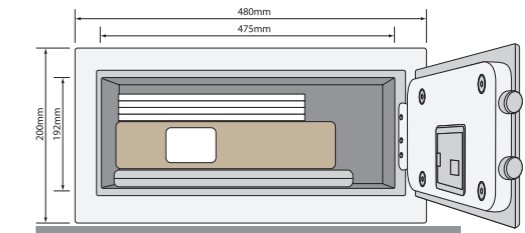

YSB/250/EB1

Security Safe Home

- Exterior dimensions** | 250 (H) x 350 (W) x 300 (D) mm
- Interior dimensions** | 242 (H) x 345 (W) x 245 (D) mm
- Net weight** | 13kg
- Quantity / Ctn** | 1
- Unit Price** | RM1,030.00

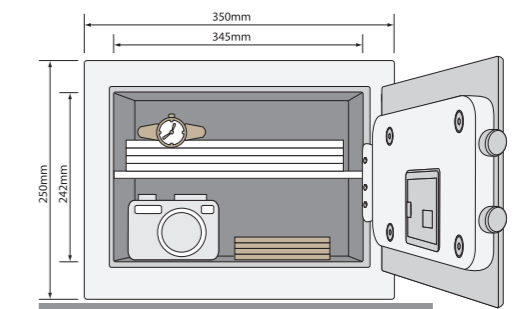

Security Safe Home Safe Box



Security Safe

Economic option of security digital safes for good burglary protection.

Locking System	6 lever double - bitted override locking system
Battery	4 x AA Size (1.5V x 4)
Finishes	Matt black faceplate Powder coated interior
Mounting	Wall Mount
Key System	Key Override Function
No of Key	2



YSB/200/EB1

Security Safe Compact

Exterior dimensions	200 (H) x 350 (W) x 200 (D) mm
Interior dimensions	192 (H) x 345 (W) x 145 (D) mm
Net weight	9kg
Quantity / Ctn	1
Unit Price	RM859.00

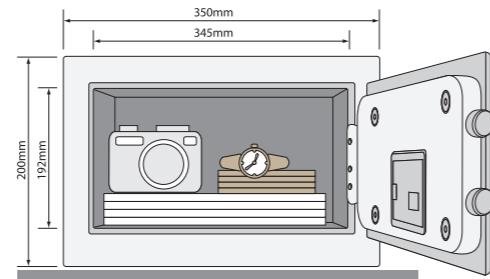

Value Safe Home Safe Box



Value Safe - The most valued model with simple & clean panel design

- Good quality entry point digital safe product

Locking System	16mm steel locking bolts
Battery	4 x AA Size (1.5V x 4)
Protection	Time lock sets in wrong code is entered more than 3 times
Mounting	Wall Mount
Key System	Key Override Function
No of Key	2



YSV/250/DB1

Value Safe

Exterior dimensions	250 (H) x 350 (W) x 250 (D) mm
Interior dimensions	240 (H) x 340 (W) x 200 (D) mm
Net weight	8kg
Quantity / Ctn	1
Unit Price	RM410.00

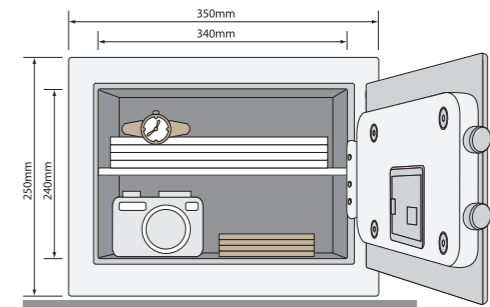

YSB/400/EB1

Security Safe Office

Exterior dimensions	400 (H) x 350 (W) x 340 (D) mm
Interior dimensions	392 (H) x 345 (W) x 285 (D) mm
Net weight	19kg
Quantity / Ctn	1
Unit Price	RM1,320.00

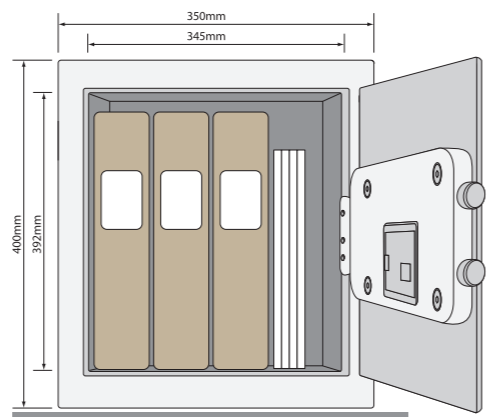

YSV/390/DB1

Value Safe

Exterior dimensions	390 (H) x 350 (W) x 360 (D) mm
Interior dimensions	380 (H) x 340 (W) x 310 (D) mm
Net weight	14kg
Quantity / Ctn	1
Unit Price	RM640.00

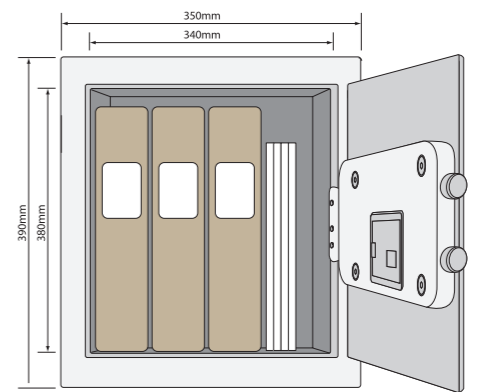

Elite Safe Home Safe Box

Yale

Elite Safe - Excellent value to price motorized digital safe
- Perfect choice at middle range digital safe

Locking System	Motorized bolts, high quality zinc plated steel bolts
LED Display	3-6 digitals combination
Battery	4 x AA Size (1.5V x 4)
Mounting	Wall Mount
Key System	Key Override Function
No of Key	2



YSEL/200/EG7

Elite Safe

Exterior dimensions	200 (H) x 310 (W) x 200 (D) mm
Interior dimensions	197 (H) x 307 (W) x 137 (D) mm
Net weight	6.8kg
Quantity / Ctn	1
Unit Price	RM600.00

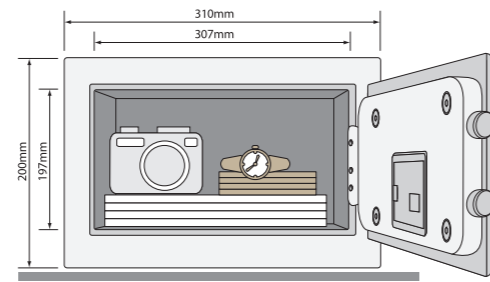

YSEL/390/EG7

Elite Safe

Exterior dimensions	390 (H) x 350 (W) x 360 (D) mm
Interior dimensions	387 (H) x 347 (W) x 305 (D) mm
Net weight	14.3kg
Quantity / Ctn	1
Unit Price	RM1,070.00

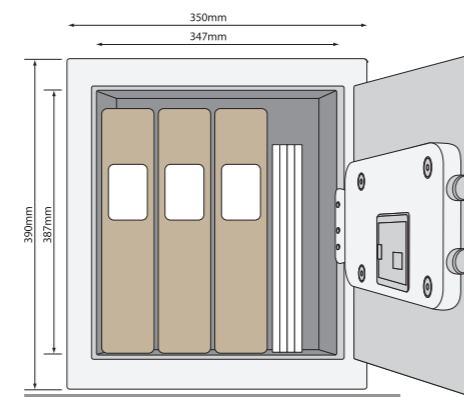

Cash Box Mini Safe Box

Yale

Cash Box

Yale cash box is a friendly helper for home, small business, office & clubhouse



YCB/080/BB2

Small Cash Box

Exterior dimensions	80 (H) x 152 (W) x 118 (D) mm
Net weight	0.6kg
Features and Benefit	-Handy carry handle -Inside with plastic tray -Cylinder lock -Come with 2 keys
Quantity / Ctn	6 pcs
Unit Price	RM62.00



YCB/090/BB2

Medium Cash Box

Exterior dimensions	90 (H) x 200 (W) x 160 (D) mm
Net weight	0.9kg
Features and Benefit	-Handy carry handle -Inside with plastic tray -Cylinder lock -Come with 2 keys
Quantity / Ctn	6 pcs
Unit Price	RM80.00

Key Box Mini Safe Box

Yale

YKB/200/BB2

Key Box

Exterior dimensions | 80 (H) x 200 (W) x 160 (D) mm
Net weight | 0.9kg
Features | Wall Mount
Quantity / Ctn | 6 pcs
Unit Price | **RM83.00**

YKB/540/BB2

Key Box

Exterior dimensions | 80 (H) x 300 (W) x 240 (D) mm
Net weight | 2kg
Features | Wall Mount
Quantity / Ctn | 6 pcs
Unit Price | **RM117.00**

YKB/200/CB2

Combination Key Box

Exterior dimensions | 80 (H) x 200 (W) x 160 (D) mm
Net weight | 0.9kg
Features | Wall Mount
Quantity / Ctn | 6 pcs
Unit Price | **RM83.00**

YKB/540/CB2

Key Box

Exterior dimensions | 80 (H) x 300 (W) x 240 (D) mm
Net weight | 2kg
Features | Wall Mount
Quantity / Ctn | 6 pcs
Unit Price | **RM125.00**



Yale



yalehome.com

ASSA ABLOY Opening Solutions Malaysia Sdn Bhd
Level 1, East Wing, Wisma Consplant 1
No 2, Jalan SS16/4
47500 Subang Jaya
Selangor, Malaysia
Tel: +60 3 5651 7800
Fax: +60 3 5613 3889
yalehome.com.my
info@yale.com.my

ASSA ABLOY Philippines
Unit A Ground Floor Suntime Tower #13
Meralco Ave., Ortigas Center, Pasig City
yalehome.com.ph
info.ph@assaabloy.com

ASSA ABLOY Taiwan
2F, No 217 Section 3, Chengde Road
Datong District, Taipei City 103, Taiwan (R.O.C)
Tel: +886 2 2586 0161
Fax: +886 2 2586 0171
yalehome.com.tw
sales.tw@assaabloy.com

ASSA ABLOY Hong Kong Limited
16.F Excel Centre, 483A Castle Peak Road
Cheung Sha Wan, Kowloon, Hong Kong
Tel. +852 22607288 / 22600888
Fax. +852 26868682 / 2834 5507
yalehome.com.hk
sales.hk@assaabloy.com

ASSA ABLOY (Thailand) Ltd
1919, 5th Floor
Preecha Group Building
Pattanakarn Road, Suanluang
Bangkok, 10250 Thailand
Tel: +66 2 722 7371
Fax: +66 2 722 7375
yale.co.th
info.th.opening@assaabloy.com

ASSA ABLOY Singapore Pte Ltd
#08-08 Siemens Center Blk 1
60 MacPherson Road
348615 Singapore
Tel: +65 6880 0000
Fax: +65 6880 0500
yalehome.com.sg
sales@assaabloy.com.sg

ASSA ABLOY Vietnam
20th floor, 2 Bis - 4 -6, Le Thanh Ton St
Ben Nghe Ward, Dist 1, Ho Chi Minh City
Tel: +84 28 2249 8833
yalehome.com.vn
info.vn@yalelock.com

PT ASSA ABLOY Indonesia
Unit 316, 3rd Floor, Marga Guna Grand
JI Marga Guna Raya, No 9, Pondok Indah
Jakarta, 12420 Indonesia
Tel: +62 21 720 6884
Fax: +62 21 720 6874
info.id@assaabloy.com

Legal Disclaimer:

While every effort has been made to ensure that the information contained in this brochure is accurate at the time of its publication, yet ASSA ABLOY reserves its right to make changes in its products without prior notice. ASSA ABLOY will not be liable for any loss, injury or damage arising out of use of its products. The brochure does not constitute offer for sale of its products. ASSA ABLOY advises the use of its products for installation only by trained technicians.



SCAN & EMAIL ME